

AGENDA**HISTORIC LANDMARKS COMMISSION**

January 22, 2025

4:00 p.m.

City Hall Council Chambers
313 Court Street, The Dalles, Oregon

Via Zoom

<https://us06web.zoom.us/j/83000976030?pwd=Y3NwM1NPVUk3anVPUjNTdythYW1sZz09>

Meeting ID: **830 0097 6030** Passcode: **22217**

Dial: 1-669-900-6833 or 1-253-215-8782

Upon request, the City will make a good faith effort to provide an interpreter for the deaf or hard of hearing at regular meetings if given 48 hours' notice. To make a request, please contact the City Clerk and provide your full name, sign language preference, and any other relevant information.

Contact the City Clerk at (541) 296-5481 ext. 1119, or amell@ci.the-dalles.or.us.

1. CALL TO ORDER
2. ROLL CALL
3. PLEDGE OF ALLEGIANCE
4. APPROVAL OF AGENDA
5. APPROVAL OF MINUTES – November 20, 2024
6. PUBLIC COMMENT – During this portion of the meeting, anyone may speak on any subject that does not later appear on the agenda. Five minutes per person will be allowed.
7. PUBLIC HEARING
 - A. HLC Application 217-24, Denise Dietrich-Bokum, FDMAH Foundation, 500 W. 15th Street

Request: Approval for the demolition of, and new replacement construction of a vehicle storage building to house historic wagons.
 - B. HLC Application 218-24, Tom Giamei, 201 E. 2nd Street

Request: Approval to replace four windows on the northeast wall and one door facing Court Street.

8. RESOLUTION

A. HLC Resolution 203-25, Denise Dietrich-Bokum, FDMAH Foundation, 500 W. 15th Street

B. HLC Resolution 204-25, Tom Giamei, 201 E. 2nd Street

9. GOAL SETTING – Final review

10. STAFF COMMENTS

11. COMMISSIONER COMMENTS

12. ADJOURNMENT

Meeting conducted in a room in compliance with ADA standards.

Prepared by/
Paula Webb, Secretary
Community Development Department

SPECIAL MEETING
MINUTES

HISTORIC LANDMARKS COMMISSION MEETING
November 20, 2024
4:00 p.m.

CITY HALL COUNCIL CHAMBERS
313 Court Street, The Dalles, Oregon 97058
Via Zoom / Livestream via City Website

PRESIDING: Robert McNary, Chair

COMMISSIONERS PRESENT: Bev Eagy, Forust Ercole, Eric Gleason, Karl Vercouteren

OTHERS ABSENT: City Councilor Scott Randall, Museum Commission Representative Julie Reynolds

STAFF PRESENT: Director Joshua Chandler, Senior Planner Sandy Freund, Secretary Paula Webb

CALL TO ORDER

The meeting was called to order by Chair McNary at 4:00 p.m.

PLEDGE OF ALLEGIANCE

Commissioner Eagy led the Pledge of Allegiance.

APPROVAL OF AGENDA

It was moved by Eagy and seconded by Gleason to approve the agenda as presented. The motion carried 5/0; Eagy, Ercole, Gleason, McNary and Vercouteren voting in favor, none opposed.

APPROVAL OF MINUTES

Commissioner Vercouteren noted J. Scott Stephenson was included in “Commissioners Present” instead of Commissioner Vercouteren. Mr. Stephenson was not in attendance.

It was moved by Vercouteren and seconded by Gleason to approve the minutes of August 28, 2024 as corrected. The motion carried 5/0; Eagy, Ercole, Gleason, McNary and Vercouteren voting in favor, none opposed.

MINUTES

Historic Landmarks Commission Meeting

November 20, 2024

Page 2 of 4

ELECTION OF OFFICERS

Commissioner Eagy nominated Robert McNary for Chair. Commissioner Vercouteren seconded the nomination. Vercouteren then moved for a unanimous vote. The motion carried 5/0; Eagy, Ercole, Gleason, McNary and Vercouteren voting in favor, none opposed.

Chair McNary nominated Forust Ercole for Vice Chair. Commissioner Eagy seconded the nomination. Commissioner Vercouteren then moved for a unanimous vote. The motion carried 5/0; Eagy, Ercole, Gleason, McNary and Vercouteren voting in favor, none opposed.

PUBLIC COMMENT

None.

2025 GOAL SETTING

Director Chandler introduced the City's new Senior Planner, Sandy Freund. Senior Planner Freund will oversee the Historic Landmarks program.

Senior Planner Freund presented the staff report. She recommended the Board consider a restructuring exercise to prioritize and achieve goals effectively in the coming years. Staff suggested defining goal terms more clearly: short-term goals as one to two years, medium-term goals as three to five years, and continuous goals greater than five years.

The Commission reviewed and updated their 2025 goals, focusing on updating historic inventories, encouraging new nominations to local and national registries, and maintaining Certified Local Government status. Specific goals include providing historic restoration workshops, creating concept designs for historic building plaques, and supporting the preservation of the Waldron Drug/Gitchell building.

The Commission also discussed the potential for adding new goals related to the historical significance of buildings along the railroad and the importance of informing real estate buyers about historic property requirements.

Additional topics included the addition of a short-term goal to research the Rock House and the development of a GIS map to include historic property designations. The GIS map, expected by spring, will provide property information, including historic designations.

Concerns were raised about the First Street project's impact on historic properties. The meeting also touched on the importance of preserving historic resources and the potential for new residential grants.

Staff will return at the January meeting with the 2025 Goals for approval.

COMMISSIONER COMMENTS

Commissioner Vercouteren noted the Original Courthouse Board would meet tomorrow to discuss potential programs for the February Regional History Forum. He invited anyone with ideas to share them with him or Commissioner Gleason.

MINUTES

Historic Landmarks Commission Meeting

November 20, 2024

Page 3 of 4

Commissioner Gleason raised two concerns. First, regarding the Fort Dalles Museum application, he noted the city's new application process is intended to assist staff in writing reports and guiding applicants to provide sufficient information. However, the current combined application for remodels, new construction, and landmark status has caused confusion. He suggested splitting the application into separate forms, particularly separating landmark designation requests, to simplify the process.

Second, he expressed concerns about the First Street project. While acknowledging the need for improvements due to the deterioration of paving and sidewalks observed over the past 40 years, he emphasized the importance of protecting historic properties, particularly the stone retaining walls around the Chinatown site. He argued for prioritizing the preservation of these walls, as replacing them with gabion walls would not be ideal aesthetically, historically, or potentially cost-wise. Minimizing land disturbance and avoiding impacts on historic resources would likely save money in the long term by reducing the risk of unforeseen expenses associated with archeological sites.

Commissioner Vercouteren inquired about the Walking Tour, specifically the Otocast app and its functionality. He questioned the app's longevity, noting he had encountered information suggesting it requires periodic renewal and payment to maintain its connection.

Director Chandler explained that the Otocast app operates under an annual license or agreement. While it was included in last year's budget, he needs to verify its status for the upcoming year. He noted that user engagement has been relatively low, which raises concerns about the value of ongoing payments for the service.

Chandler added that continued payment ensures access to updates, including software improvements. If the subscription lapses, the program would likely remain functional but without updates, effectively leaving users with an outdated version. He offered to investigate further if there is interest in maintaining the service.

STAFF COMMENTS

Director Chandler mentioned that the Fort Dalles Museum/Anderson Homestead is considering replacement of the vehicle storage building. Chandler noted the goal is to bring this matter before the Board at the January meeting.

Chair McNary asked if any topics at the Urban Renewal Agency meeting would be important to the Historic Landmarks Commission.

Director Chandler emphasized that increasing the maximum indebtedness for urban renewal would provide more funding for the Urban Renewal Incentive Program. This program currently offers three grant types:

- **Facade Improvement Grant:** Provides up to \$50,000 as a 50/50 match for property owners undertaking projects such as facade improvements to historic buildings downtown. For example, a \$100,000 project would receive \$50,000 in funding.

MINUTES

Historic Landmarks Commission Meeting

November 20, 2024

Page 4 of 4

- **Residential Dwelling Grant:** Offers \$10,000 per residential unit added to the urban renewal district, such as converting vacant upper-floor spaces in downtown buildings into residential units. This funding can help cover system development charges.
- **Mixed-Use Grant:** Allocates up to \$150,000 for projects classified as mixed-use, combining residential and commercial components.

If the substantial amendment is approved, additional funds would be allocated to this program, and staff are exploring potential modifications. Proposed changes include increasing grant amounts and introducing a new residential grant to support upgrades to residential properties within the urban renewal district, which includes downtown and areas extending west and south of Webber Street.

Chandler also mentioned the Tony’s Building site redevelopment, which is currently under review by a selection advisory committee. Once a proposal is chosen, the project will require Historic Landmarks Commission (HLC) review to ensure alignment with preservation goals.

These initiatives align with broader goals of historic preservation and revitalization in The Dalles.

ADJOURNMENT

Being no further business, the meeting adjourned at 5:57 p.m.

Meeting conducted in a room in compliance with ADA standards.

Submitted by/
Paula Webb, Secretary
Community Development Department

SIGNED:

Robert McNary, Chair

ATTEST:

Paula Webb, Secretary
Community Development Department



STAFF REPORT
Historic Landmarks Commission
HLC 217-24

Denise Dietrich-Bokum, Fort Dalles Museum and Anderson Homestead Foundation

Procedure Type:	Quasi-judicial
Assessor's Map:	Township 1N 13E Section 4 DB
Tax Lots:	10400
Address:	500 W. 15 th and Garrison Streets
Zoning District:	Parks and Open Space (P/OS)
Historic Status:	National Register Property & Primary – Local Landmark Inventory #55
Historic District:	N/A
Existing Use:	Fort Dalles Museum
Prepared by:	Sandy Freund, Senior Planner
Date prepared:	January 15, 2024

REQUEST: Approval for the demolition and new replacement construction of a vehicle storage building to house historic wagons.

A detailed list of the proposed materials for the replacement wagon shed is included in the application materials.

NOTIFICATION: Published advertisement in local newspaper, appearing two consecutive weeks, with the first at least 20 days prior to the hearing (January 1, 2025), notification to property owners within 100 feet, and State Historic Preservation Office (SHPO).

BACKGROUND: The Fort Dalles Museum is the location and site of the Fort Dalles Surgeon's Quarters, which includes the Gardner's Cottage, c 1856. There are two vehicle storage buildings, which were added in 1953 and 1964, both of which are not listed in the historic inventory. The applicant proposes to demolish the dilapidated three-sided wagon shed, constructed in 1964, located on the southwest corner of the property, and construct a new enclosed building to house, display and protect the historic wagons.

ANALYSIS: The Historic Landmarks Commission (Commission) is responsible for conducting hearings associated with proposed alterations to historic buildings. The Dalles Municipal Code (TDMC), Title 11 Planning, Chapter 11.12 Historic Resources, provides process as well as established design guidelines to assist the Commission in making these decisions. The purpose of the Commission, Chapter 11.12, and associated review criteria is to:

- *Protect historic and cultural resources from destruction, inappropriate alteration, and incompatible adjacent development;*
- *Stabilize and improve property values in historic districts and City-wide;*
- *Enhance the City's attractiveness to visitors and residents, and stimulate business, industry, and tourism;*
- *Educate The Dalles' citizens and visitors concerning the City's heritage;*
- *Preserve the historic housing stock of The Dalles; and*
- *To comply with The Dalles Comprehensive Plan regarding historic resources under Statewide Planning Goal 5.*

REVIEW CRITERIA:

City of The Dalles Municipal Code, Chapter 11.12 Historic Resources

Article 11.12.070, Section A. Review Criteria

3. *Secretary's Standards. Commission decisions shall be based on the Secretary of the Interior's Guidelines for the Treatment of Historic Properties. Findings #1 - #10 are pertinent standards from the Secretary of the Interior's Guidelines for the Treatment of Historic Properties.*

1. ***A property shall be used for its historic purpose or be placed in a new use that required minimal change to the defining characteristic of the building and its site and environment.***

FINDING #1: Applicant will retain the purpose and use of the site. The subject property is the site of the old Fort Dalles complex, first established as Camp Drum in 1850 and was the only post between Fort Vancouver and Fort Laramie. The only remaining building of old Fort Dalles is the Surgeon's Quarters, which is Oregon's premier example of the Gothic Revival Style house architecture. In 1953, the American Legion Post #19, with assistance from the Carpenter's Union, constructed the first vehicle display building on the grounds of Fort Dalles Museum to house the historic vehicle collection. That finished building was wood framed with corrugated aluminum metal siding and roofing. Over time the building deteriorated and was and the siding was replaced in 2020 after receiving approval from the HLC (File # HLC-176-20). A second vehicle storage shed, constructed in 1964, is now in deteriorated condition and is the subject of this application review. The applicant seeks approval to demolish the existing shed and rebuild it using new materials to better protect the historic wagons currently on display at the museum complex. **Criterion met.**

- 2. The historic character of a property shall be retained and preserved. The removal of historic materials or alterations of features and spaces that characterize a property shall be avoided.*

FINDING #2: Applicant requests reconstruction of the shed due to its unsafe conditions and potential damage to the historic wagons as a result of rotting wood posts supporting the structure. Due to poor initial construction and insufficient maintenance, water runoff has caused sections of the shed's wood to rot, contributing to its overall deterioration. The shed roof was constructed of various materials (plywood, skip sheathing, and tin), with supports added over the years to stabilize the structure. As mentioned, water runoff has rotted several sections of the wood structure, leading to unsafe structural conditions, as determined by an inspection completed for the applicant by a licensed contractor. The new shed structure will be constructed using complementary materials and a cohesive design, including Hardie Plank board and batten siding that mimics the appearance of wood, a 35-year composition roof, white vinyl windows, and metal-insulated garage doors. The applicant intends to preserve the existing foundation and add board-and-batten Hardie Plank siding, along with a carriage house-style design on the east side of the structure, which is currently open.

The new shed will be fully enclosed and insulated to protect the antique wagons from the elements. Designed to blend in with the historic Surgeon's Quarters and other structures on the site, the new structure will differ from the recently updated vehicle display building, which features wood framing with corrugated aluminum siding and roofing. As stated in **Finding #1**, the design of this vehicle display building was reviewed and approved by the HLC on February 12, 2020 (File # HLC 176-20). No removal or modifications to the Surgeon's Quarters structure or other site structures is proposed. Staff encourages additional discussion with the Commission regarding the colors of the proposed vinyl windows. **Criterion met.**

- 3. Each property shall be recognized as a physical record of its time, place, and use. Changes that create a false sense of historical development, such as adding conjectural features or architectural elements from other buildings, shall not be undertaken.*

FINDING #3: Applicant is not proposing any exterior modifications that will create a false sense of historical development, with the replacement construction of the existing three-side shed intended to make the structure safe and protect the antique wagons from the elements. Staff finds that the proposed work does not create a false sense of historical development as it will not alter any historic feature. **Criterion met.**

- 4. Most properties change over time; those changes that have acquired historic significance in their own right shall be retained and preserved.*

FINDING #4: The existing site will be retained as the Surgeon's Quarters and Anderson Homestead. The existing vehicle display shed, which is the focus of this review, is not listed on the 1985 historic inventory sheet for the site. The proposed removal and replacement of this three-sided shed constitutes a modification to an accessory structure only, and will not affect the historic Surgeon's Quarters or the designated historic site landmark. All original uses and structures on the site will be preserved and retained. **Criterion met.**

- 5. Distinctive features, finishes, and construction techniques or examples of craftsmanship that characterize a property shall be preserved.*

FINDING #5: Applicant has provided a list of materials for the replacement wagon shed. The proposed replacement structure will include new materials resembling board and batten siding (Hardie Plank) designed to blend in with the Surgeon's Quarters and other structures on the site. The preservation of the existing foundation, combined with the proposed materials and architectural style, will help maintain the site's overall character and historical integrity. **Criterion met.**

- 6. Deteriorated historic features shall be repaired rather than replaced. Where the severity of deterioration requires replacement of a distinctive feature, the new feature shall match the old in design, color, texture, and other visual qualities and, where possible, materials. Replacement of missing features shall be substantiated by documentary, physical, or pictorial evidence.*

FINDING #6: Applicant is proposing demolition and replacement of the existing three-sided vehicle storage shed. The applicant states the existing shed was poorly constructed with volunteer labor in 1964, and due to limited maintenance the entire structure is in poor condition and does not adequately protect the antique wagons from the elements. The applicant also indicates that the roof was constructed using different types of materials and supports have been added over the years in order to stabilize it. The west wall of the structure (the back side) is also in poor condition, with water runoff creating rotted bottom sections of the boards. Applicant has provided with the application materials, photographs of the structure to support the request to demolish and rebuild the vehicle storage shed. **Criterion met.**

- 7. Chemical or physical treatments, such as sandblasting that cause damage to historic materials shall not be used. The surface cleaning of structures, if appropriate, shall be undertaken using the gentlest means possible.*

FINDING #7: Applicant is not proposing the use of chemical or physical treatments on the structure. **Criterion not applicable.**

- 8. Significant archaeological resources affected by a project shall be protected and preserved. If such resources must be disturbed, mitigation measures shall be undertaken.*

FINDING #8: Applicant is proposing minimal excavation and disturbance with this proposal by using the existing foundation and imported fill (approximately 110 yards) in order to level the site for the new shed. If historical artifacts are found to be over 75 years in age, all state laws and regulations will be required to be followed per the direction of the State Archeologist. In addition, the applicant will be required to submit a Physical Constraints Permit along with the associated building permit for the construction of the new structure as the total amount of cut/fill exceeds 50 cubic yards. **Criterion met with conditions.**

- 9. New additions, exterior alterations, or related new construction shall not destroy historic materials that characterize the property. The new work shall be differentiated from the old and shall be compatible with the massing, size, scale, and architectural features to protect the historic integrity of the property and its environment.*

FINDING #9: As previously mentioned, the applicant is proposing to demolish and replace the structure with new materials resembling board and batten siding designed to blend in and be compatible with the Surgeon’s Quarters and other structures on the site. The preservation of the existing foundation, combined with the proposed materials and architectural style, will help maintain the site's overall character and historical integrity. All efforts will be taken to retain the historic character of the site. **Criterion met.**

10. *New additions and adjacent or related new construction shall be undertaken in such a manner that, if removed in the future, the essential form and integrity of the historic property and its environment would be unimpaired.*

FINDING #10: No additions to the existing historic structure, the Surgeon’s Quarters, are proposed at this time. **Criterion not applicable.**

RECOMMENDATION: Based on the application materials and findings demonstrating compliance with the applicable criteria, Staff finds this proposal meets the standards of the Secretary of the Interior and The Dalles Municipal Code, Title 11- Planning, Chapter 11.12 Historic Resources and **recommends *approval of Historic Landmarks Commission No. 217-24 subject to the following conditions of approval.*** This approval is based on the applicant’s submitted plans, written narrative, and supplemental application materials received by December 10, 2024.

Conditions of Approval:

1. Work shall be completed in substantial conformance to the pictures and proposals as submitted, reviewed and modified.
2. The applicant shall submit plans for a demolition permit to the City of The Dalles and then Wasco County Building Codes.
3. The applicant shall submit plans for a building permit to City of The Dalles and then Wasco County Building Codes.
4. The applicant shall submit a Physical Constraints Permit to be reviewed and approved by the City Engineer for all cut/fill, grading, and groundwork required for the construction of the new structure.
5. If historical artifacts over 75 years old are found on the site in relation to the proposed project, resulting from land disturbance, excavation, or grading activities, all applicable state laws and regulations shall be followed in accordance with the guidance of the State Archeologist.
6. The applicant is required to notify the Community Development Department of any alteration of approved plans.



City of The Dalles
Community Development Dept
 313 Court Street
 The Dalles, OR 97058
 (541) 296-5481, ext. 1125
 www.thedalles.org

Application #: _____
 Filing Fee: _____
 Receipt #: _____
 Deemed Complete: _____
 Ready to Issue: _____
 Date Issued: _____

Received: _____

Historic Landmarks Application

This application is required for all new construction, modifications, and/or alterations to the exterior of certified historic structures and all structures within certified historic districts and reviewed by the City of The Dalles' Historic Landmarks Commission. The review criteria for each application are the Secretary of the Interior's Standards. These standards have been adopted by The Dalles Municipal Code Chapter 11.12 Historic Resources as local review criteria.

Applicant

Name: Fort Dalles Museum/Anderson Homestead Foundation
 Address: PO Box 591
The Dalles, OR 97058
 Phone #: 5417690096
 Email: info@fordallesfoundation.org

Legal Owner (if different than Applicant)

Name: Fort Dalles Museum/Wasco County
 Address: 500 W. 15th & Garrison Sts The Dalles, OR 97058
500 W. 15th & Garrison Sts The Dalles, OR 97058
 Phone #: 9712250506
 Email: firefly1345@gmail.com

Property Information

Address: 500 West 15th & Garrison Sts
 Zone: P/OS
 Current Use: Museum

Map and Tax Lot: 1N 13E DB 10400

List any known archeological resources on site:
 Refer to Archeological State Site #35-WS-00437 for complete details.

Department Use Only	
Historic Name (if any): _____	
Year(s) Built: _____	Historic Building/Site: <input type="radio"/> Yes <input type="radio"/> No
Historic Classification: _____	
Historic District: <input type="radio"/> Trevitt's Addition	<input type="radio"/> Downtown Commercial

Project Information

- New Construction Expansion/Alteration Demolition Landmark Designation

Briefly describe the proposed project:

Demolish dilapidated 3 sided wagon shed on SW corner of property. Erect new enclosed building to house, display and protect historic wagons.

Will the use change as a result of this application? Yes No

Please submit the following information with this application:

- Narrative #1: Description of the project consistent with the Secretary of Interior’s Standards for Rehabilitation (page ?)
- Narrative #2: Explanation of the project consistent with the associated project type (pages ?):
 - Landmark Designation (#2-A)
 - Alterations/New Construction/Relocation (#2-B)
 - Demolition (#2-C)
- Narrative #3: Description of the project consistent with the associated district design standards: New Construction and Alteration (page ?)
 - The Dalles Commercial Historic District (#3-A)
 - Trevitt’s Addition (#3-B)
- Narrative #4, Signs (if applicable): Description of the project consistent with the associated historic sign guideline criteria (page ?)
- Elevation drawings (existing vs. proposed)
- Current color photographs of the structure and/or site
- List of all proposed materials/colors (product brochures recommended)
- Site Plan (drawn to scale)
- Historic photographs/documentation of the structure and/or site (encouraged)
- Copy of all associated Historic Inventory information

Signature of Applicant

Denise Dutra 1-15-2024
FDMAH Foundation Date 2/11

Signature of Property Owner

Tyler Stone 1/14/25
Administrator Date

LIST OF MATERIALS FOR REPLACEMENT WAGON SHED

2,171 total sq. ft.

Quote as per plan dated 5/21/2024

Exterior

- Concrete 4' x 10' Flat sheets with 1" x 3" rough sawn Hardy trim batts 16" on-center, 5/4" x 4" Hardy trim corners
- 8" rough sawn Hardy Trim Facia
- Open Soffits with 1/2" Ruff sawn plywood
- 4" deep K style Gutters
- Laminated 35-year Composition Roofing
- White Vinyl Windows with 4"x 5/4" trim
- Metal insulated overhead garage doors (no glass) & door openers. 4 of each.
- Ext Paint 2 colors; one body color, 1 trim color

Construction

- Conventional framing - 2" x 6" - 16" on-center, 7/16" OSB sheeting with Truss roof framing 7/16" OSB roof sheeting
- Ceiling height as per plan
- R-21 fiberglass insulation and R-38 fiberglass ceiling insulation
- Concrete foundation as per plan
- 4" concrete Floor with wire reinforcing
- Standard electrical plugs & switches, 100-amp panel
- Install Electrical utilities

Interior

- MDF painted woodwork, 3 1/2" side trim with 5/4" x 4 1/2" header trim on doors & 5" x 1/2" base molding
- Kwikset Laurel style doorknobs, brushed Chrome hardware to match color with knobs
- Light orange peel sheetrock texture
- Full wrap window trim 3 1/2" side trim with 4 1/2" headers and sills
- 2 Mini split heat pump units
- Paint; ceilings one color, trim one color, body one color

OTHER

Excavation/Grading/Fills

- Fill Dirt, 110 yards
- Concrete Slab Floor, 2171 sq ft
- Footings, 35 yards
- Concrete Ramp

Lumber

- Roof trusses
- Rough framing, siding
- Finish trim, base trim

Other

- Exterior doors
- Metal brackets, hangers
- Roofing, laminated 35-year composite
- Gutters

- Windows
- Garage Doors
- HVAC, mini split (2)
- Hand railing, powder coated steel
- Drywall (interior)
- Insulation: walls R21, ceiling \$30
- Light fixtures (TBD)

BASE MAP
for
FORT DALLES MUSEUM

LOCATION:

TRACT OF LAND LOCATED IN THE NORTHWEST QUARTER OF THE SOUTHEAST QUARTER
OF SECTION 4, TOWNSHIP 1 NORTH, RANGE 13 EAST, WILLAMETTE MERIDIAN, IN THE
CITY OF THE DALLES, WASCO COUNTY, OREGON.

PAGE 1 OF 2

WASCO COUNTY
SURVEYOR'S OFFICE

OWNER:

FORT DALLES MUSEUM
500 WEST 15th STREET
THE DALLES, OREGON
97058

ZONING:

CITY OF THE DALLES
P/OS
PARKS AND OPEN SPACE

SURVEY No. _____

FILED: _____

BY: _____

LEGEND:

- FOUND MONUMENT OF RECORD, AS NOTED
- CALCULATED BOUNDARY CORNER
- () RECORD CALL
- ⊕ FIRE HYDRANT
- ⊕ W WATER VALVE
- W WATER METER
- ⊗ IRRIGATION VALVE
- ⊠ POWER TRANSFORMER/UTILITY VAULT
- ⊠ AC/HEAT UNIT
- ⊗ SANITARY MANHOLE
- PROPOSED BUILDING STAKE
- ⊠ HISTORICAL BELL
- ↑ SIGN
- ⊕ FLAGPOLE
- ◆ SONOTUBES
- ⊗ ASH(A)/ DOGWOOD(D)/ DOUGLAS FIR/ HAZEL(H) TREE
PODEROSA PINE(PP)/ WILLOW(W) TREE
- ⊗ HISTORICAL STUMP
- ⊗ BUSH
- × SPOT ELEVATION

LINE/HATCH LEGEND:

- x — EXISTING FENCE
- ▨ CONCRETE/PAVEMENT

SIGN LEGEND:

'A' = STREET SIGN

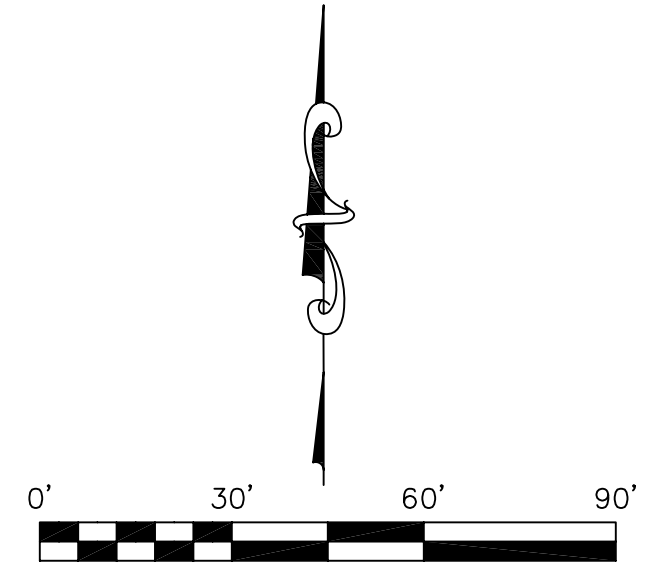
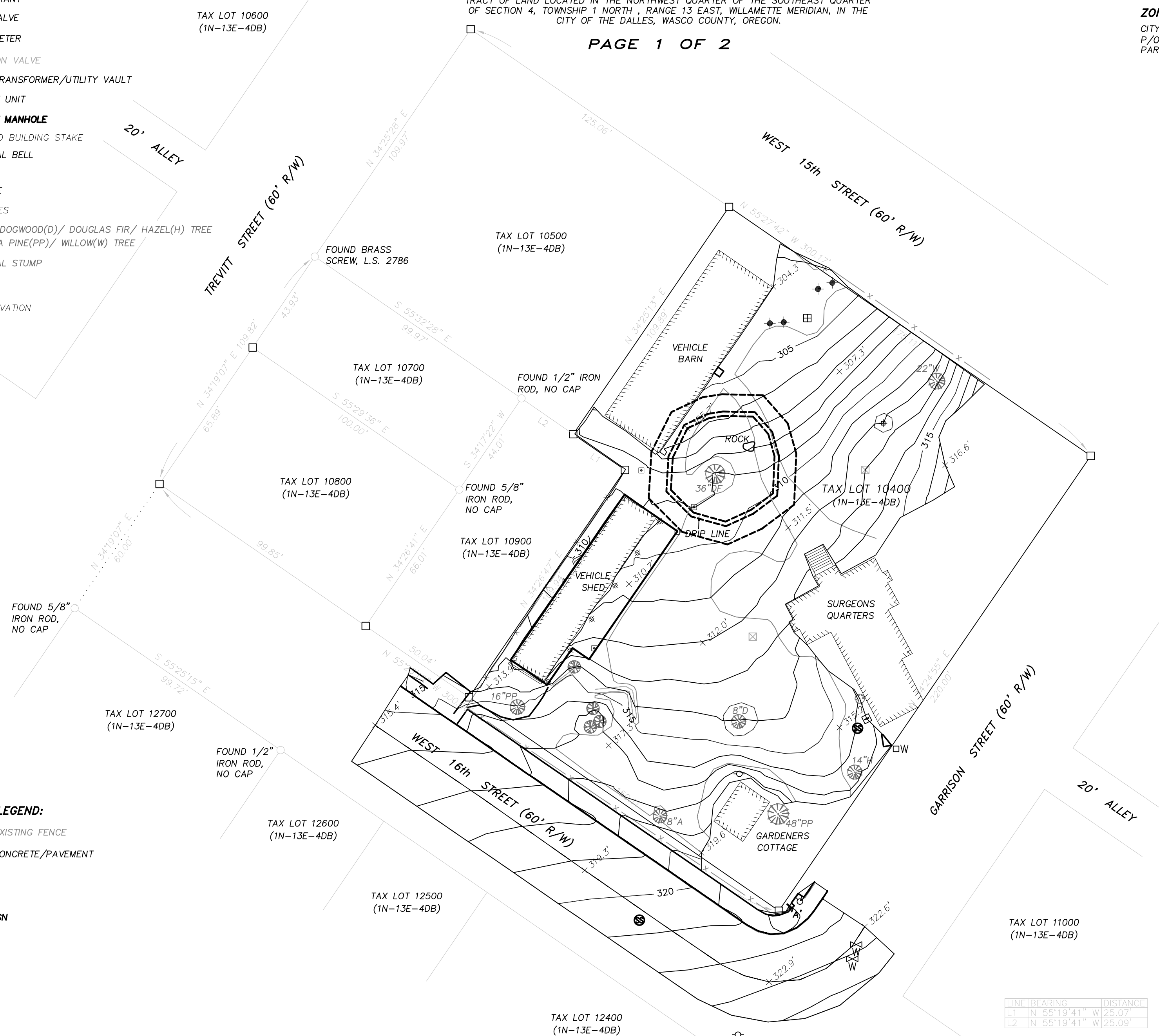

SCALE: 1" = 30'

BASIS OF BEARING:

OREGON STATE PLANE - NORTH ZONE (3601)
GRID BEARINGS AND INTERNATIONAL FEET

LINE	BEARING	DISTANCE
L1	N 55°19'41" W	25.07'
L2	N 55°19'41" W	25.09'

TERRA SURVEYING

P.O. BOX 617
HOOD RIVER, OREGON 97031
PHONE: (541) 386-4531
E-Mail: terra@gorge.net

DATE: APRIL 29, 2024
PROJECT: 24045BASEMAP
SCALE: 1" = 30'
ASSESSORS MAP: 1N-13E-4DB T.L. 10400

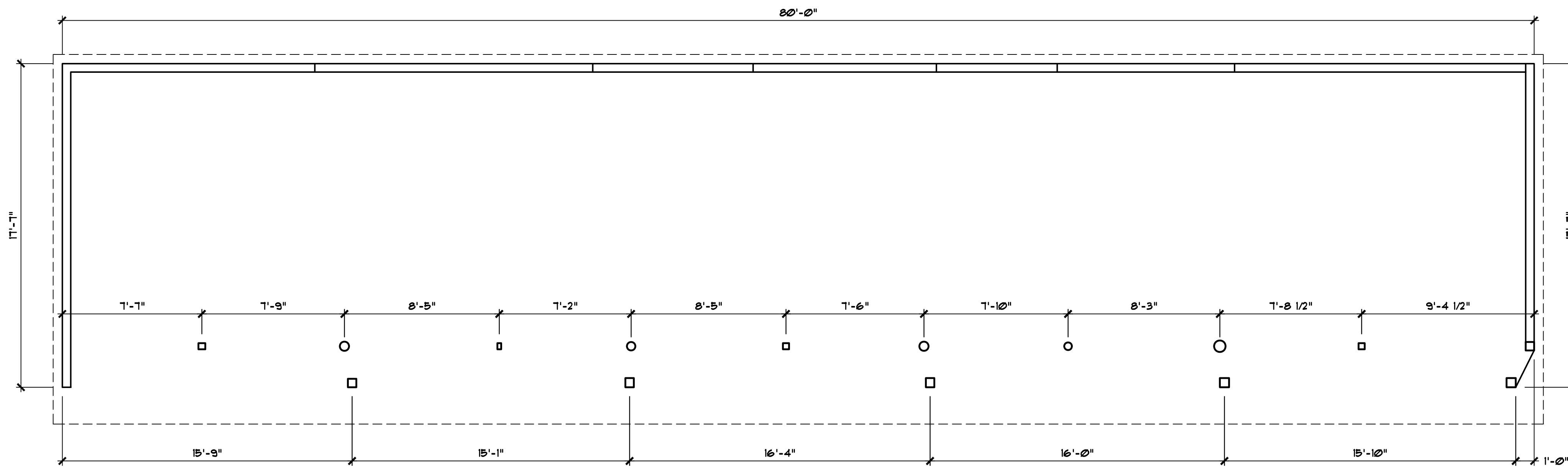

PLAN: EXISTING

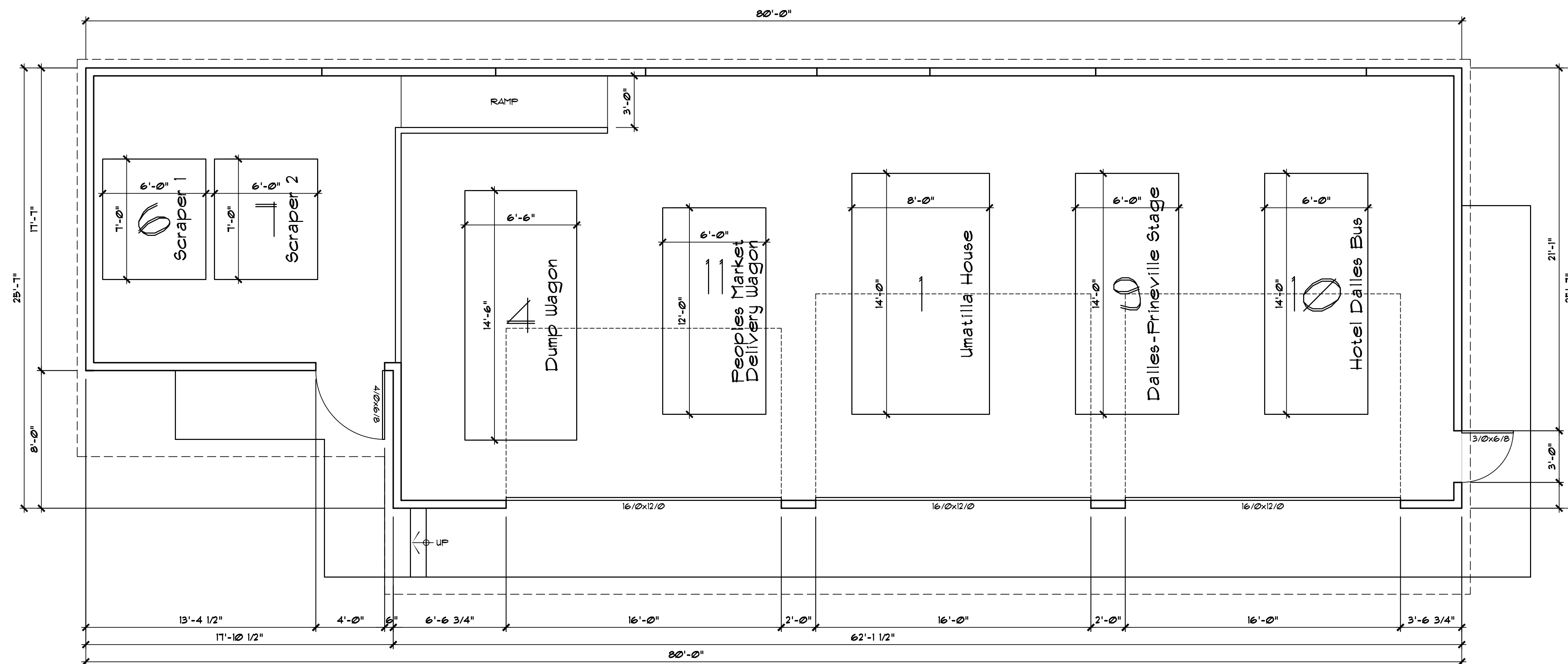

PLAN: PROPOSED

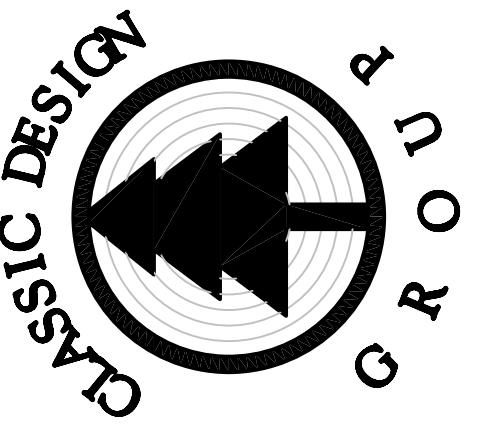

Classic Design Group

2724 East 12th Street
The Dalles, OR 97058
Phone: 541.296-8213
E-Mail: Randy@ClassicDesignGroup.com

PLAN NAME:

**Fort Dalles Museum
Vehicle Building**
500 West 15th Street
The Dalles, Oregon

AREA TABULATIONS
EXISTING FOOTPRINT: 1,406 S.F.
PROPOSED FOOTPRINT: 1,904 S.F.

SHEET DESCRIPTION:
PLAN: EXISTING
PLAN: PROPOSED

DATE: July 3, 2024

A 2
SCALE: H.L.C. Agent 1/4" = 1'-0"
January 22, 2025 | Page 17 of 54

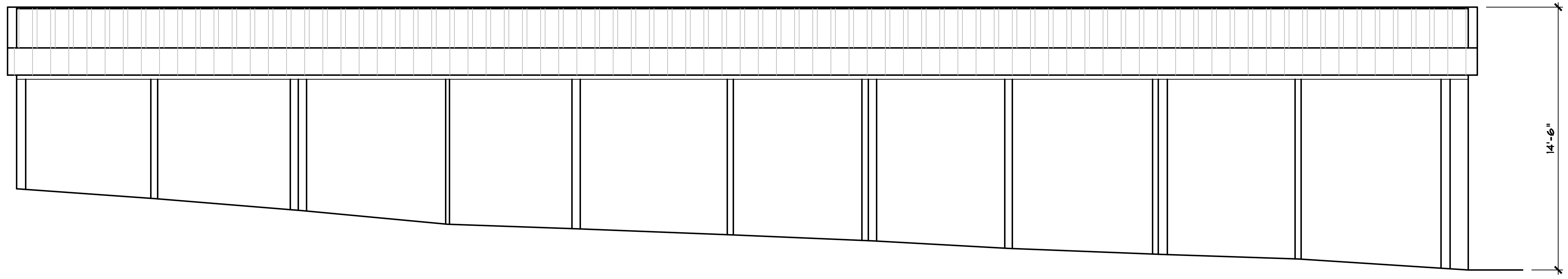

EAST ELEVATION-EXISTING

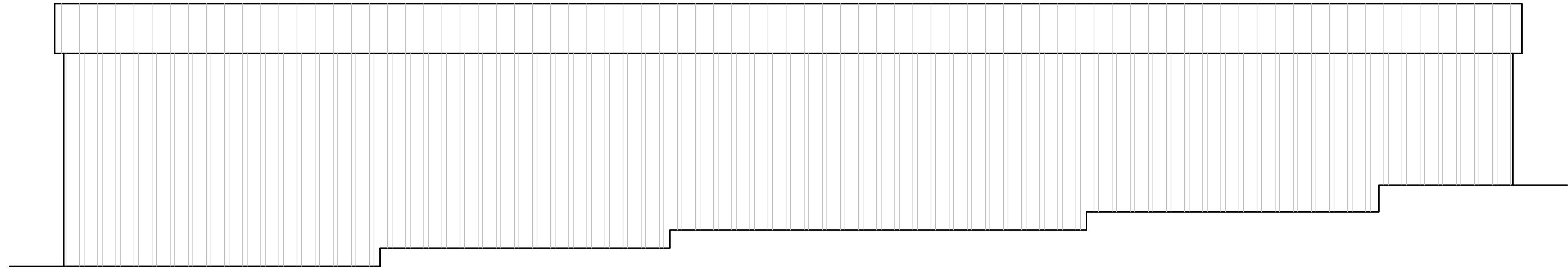

WEST ELEVATION-EXISTING

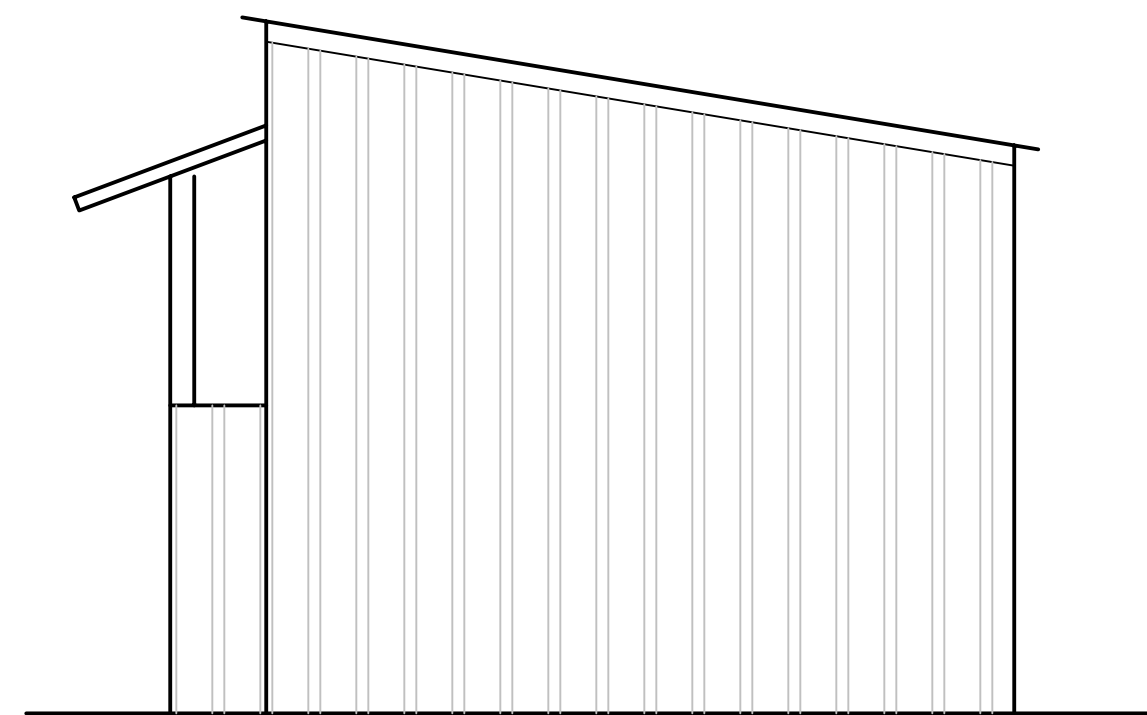

NORTH ELEVATION-EXISTING

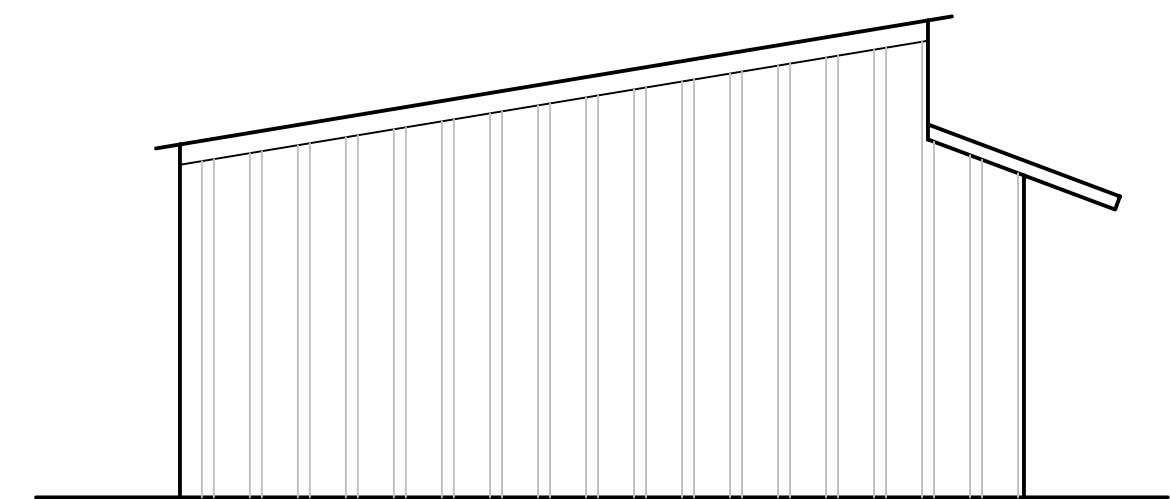

SOUTH ELEVATION-EXISTING

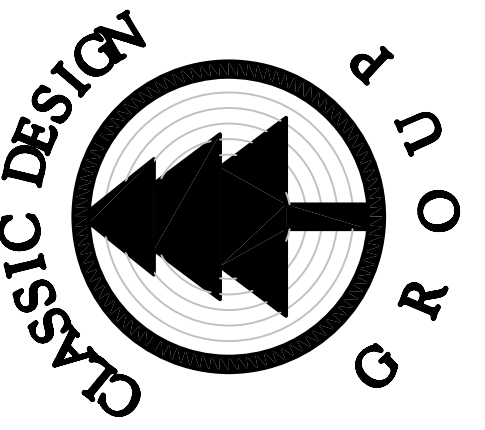

Classic Design Group
 2724 East 12th Street
 The Dalles, OR 97058
 Phone: 541.296-8213
 E-Mail: Randy@ClassicDesignGroup.com

PLAN NAME:

**Fort Dalles Museum
 Vehicle Building**
 500 West 15th Street
 The Dalles, Oregon

AREA TABULATIONS
 EXISTING FOOTPRINT: 1,406 S.F.
 PROPOSED FOOTPRINT: 1,904 S.F.

SHEET DESCRIPTION:
 ELEVATION: EXTERIOR
 EXISTING

DATE: July 3, 2024

A 3

SCALE: H.L.C. Agent 1/4" = 1'-0"
 January 22, 2025 | Page 18 of 54

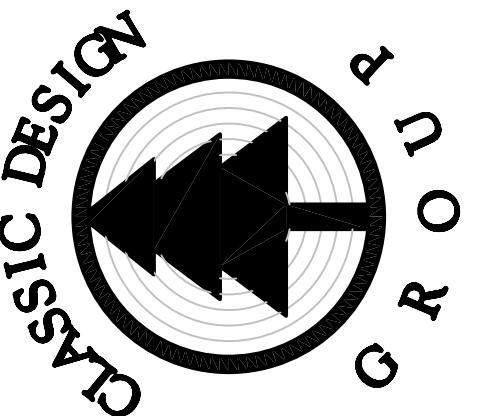

Classic Design Group

2724 East 12th Street
The Dalles, OR 97058
Phone: 541.296.8213
E-Mail: Randy@ClassicDesignGroup.com

PLAN NAME:

**Fort Dalles Museum
Vehicle Building**
500 West 15th Street
The Dalles, Oregon

AREA TABULATIONS
EXISTING FOOTPRINT: 1,406 S.F.
PROPOSED FOOTPRINT: 1,904 S.F.

SHEET DESCRIPTION:
ELEVATION: EXTERIOR
PROPOSED

DATE: July 3, 2024

A 4
SCALE: H.C. Agency 1/4" = 1'-0"
January 22, 2025 | Page 19 of 54

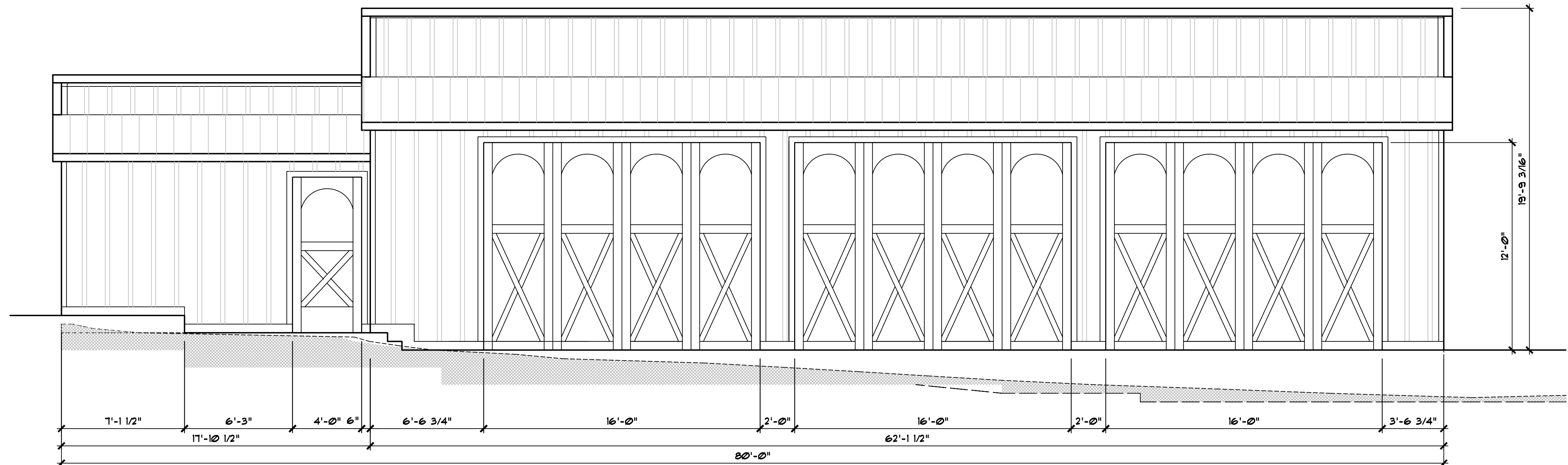

EAST ELEVATION-PROPOSED

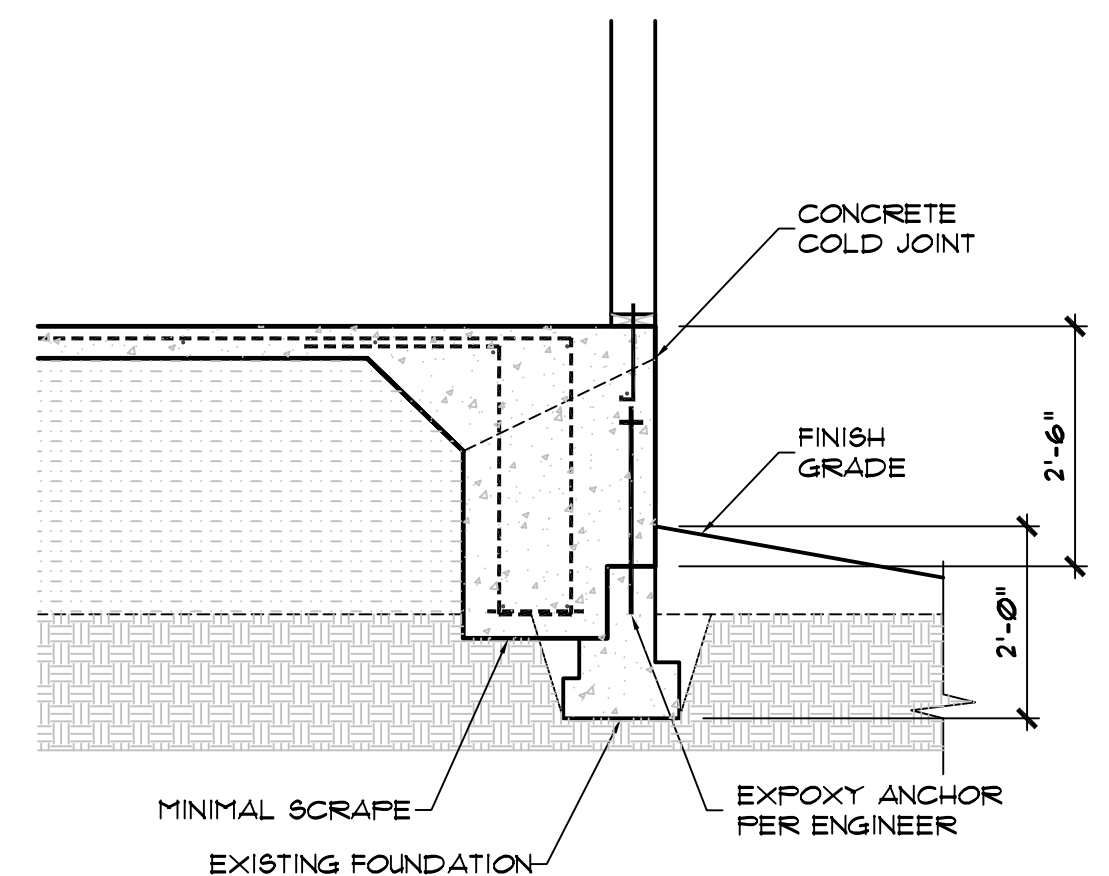

CONCRETE DETAIL PROPOSED

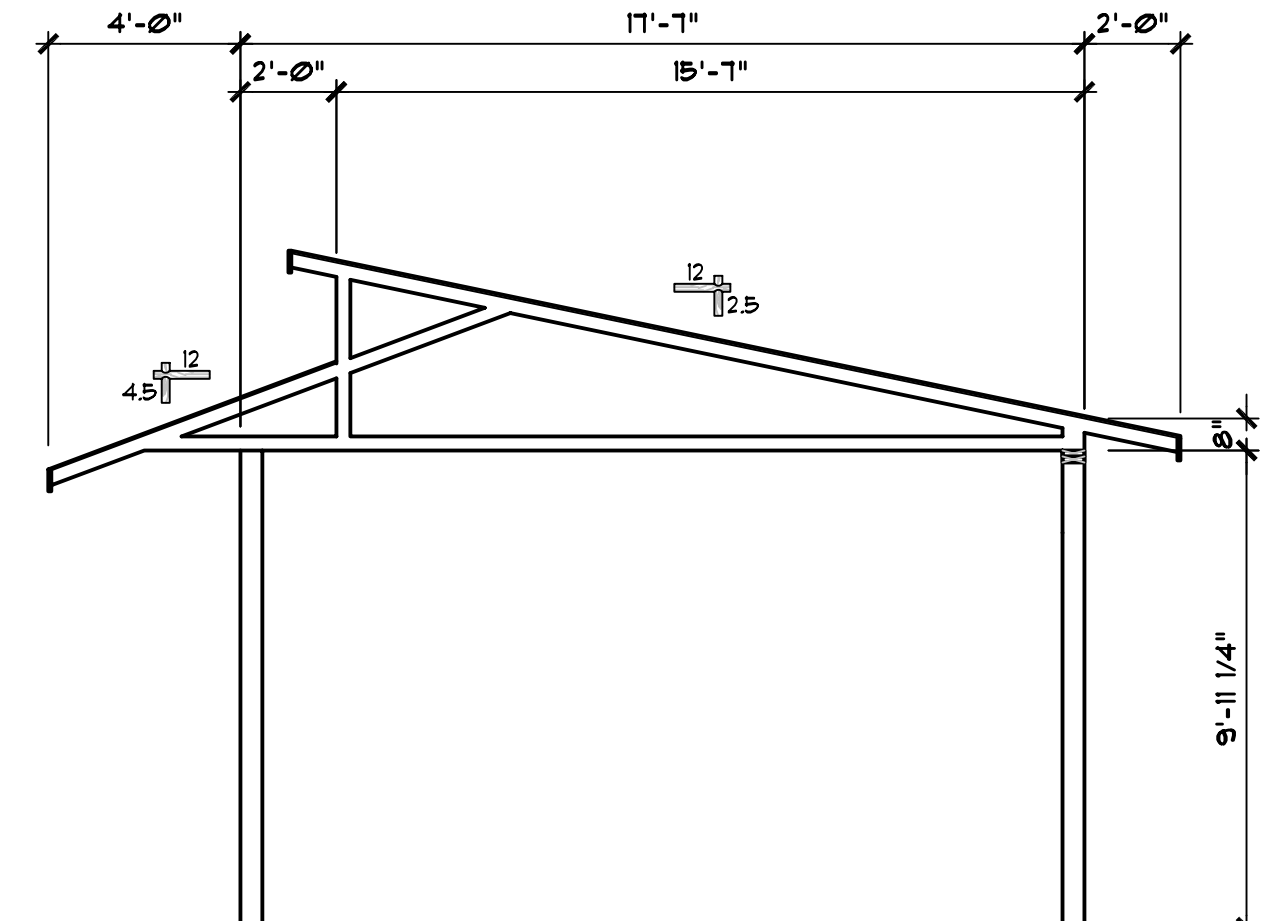

SECTION-SOUTH END PROPOSED

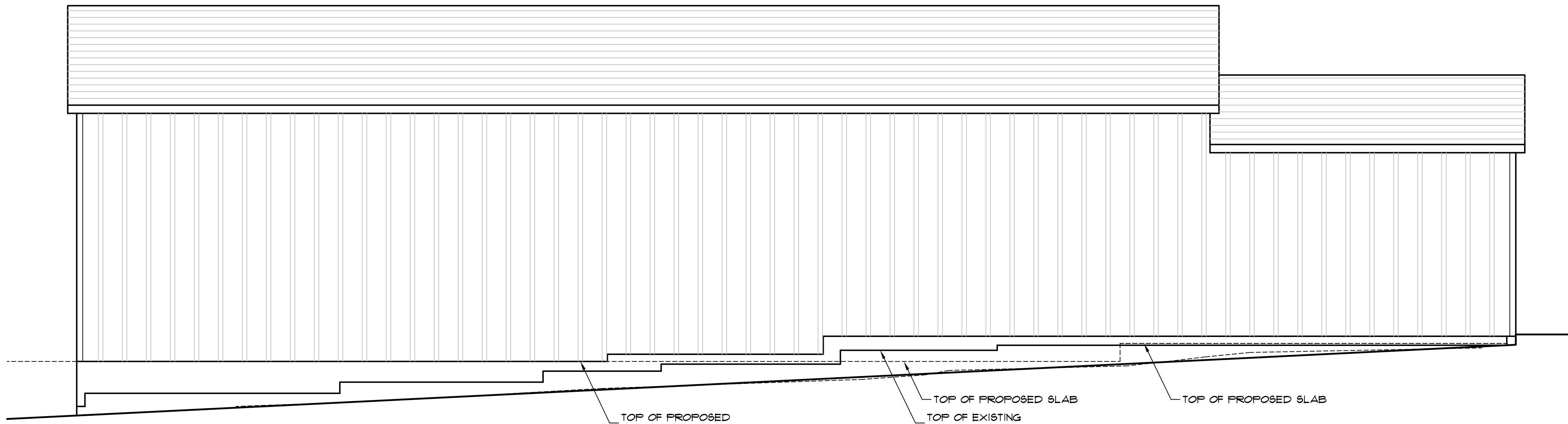

WEST ELEVATION-PROPOSED

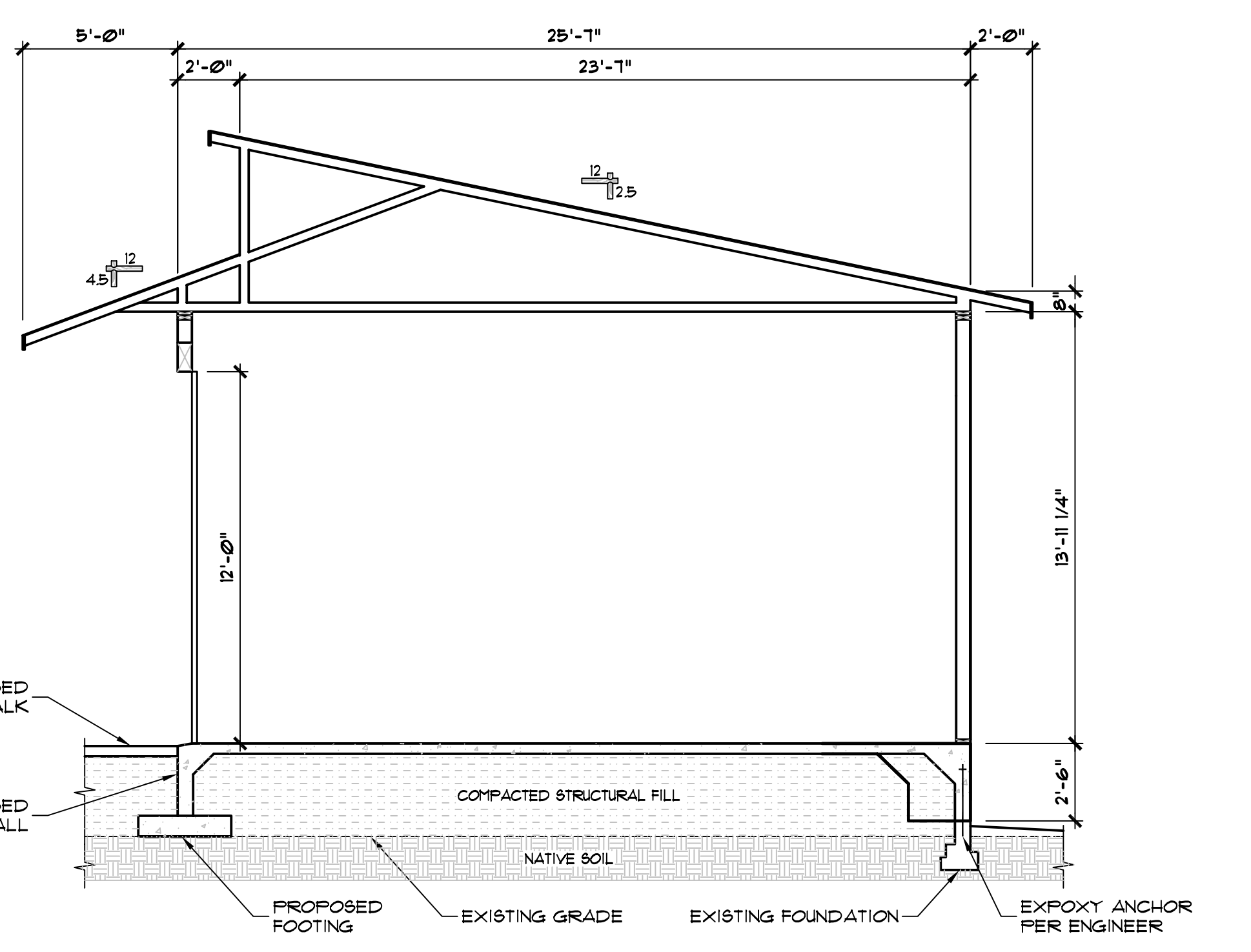

SECTION-NORTH END PROPOSED

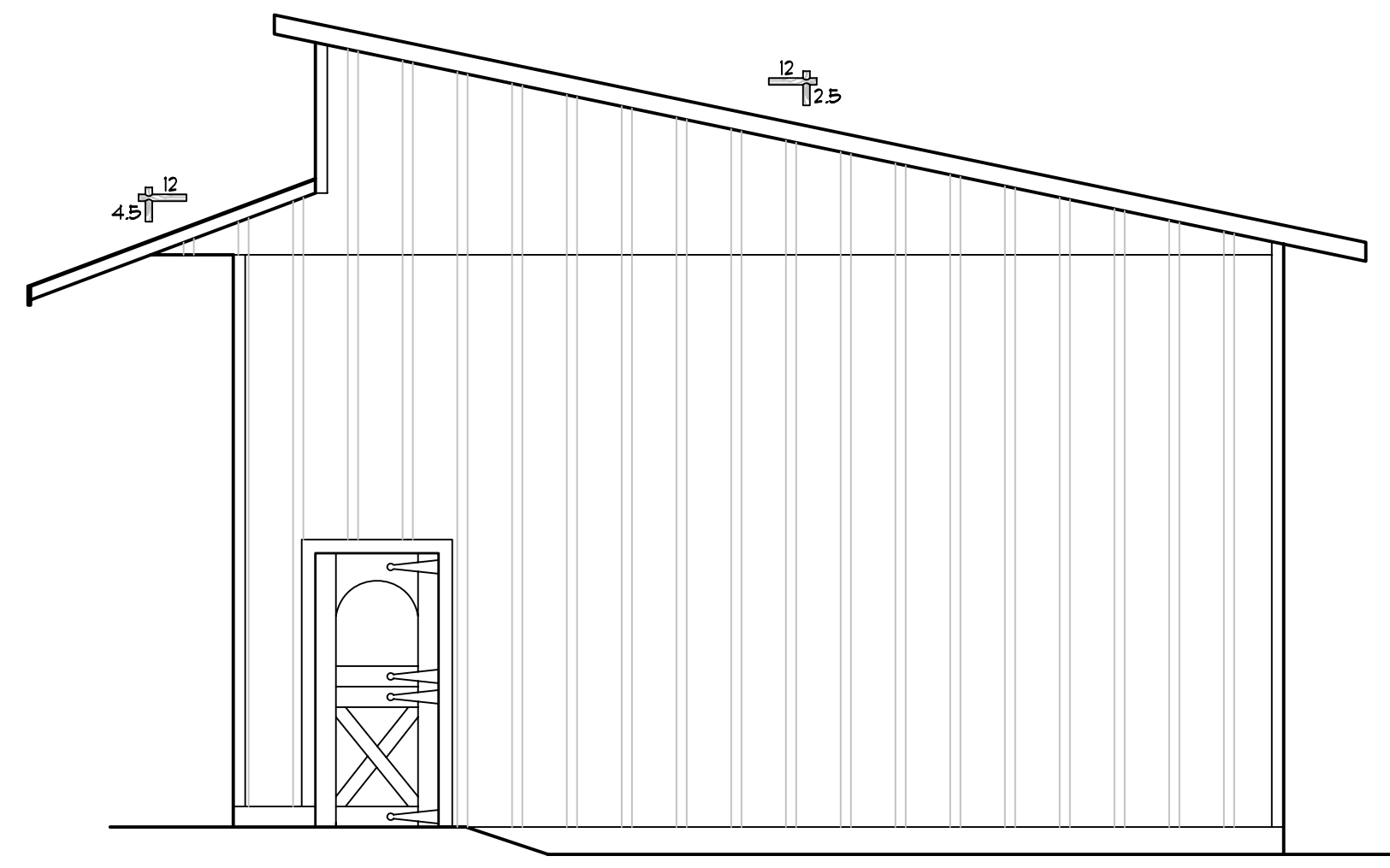

NORTH ELEVATION PROPOSED

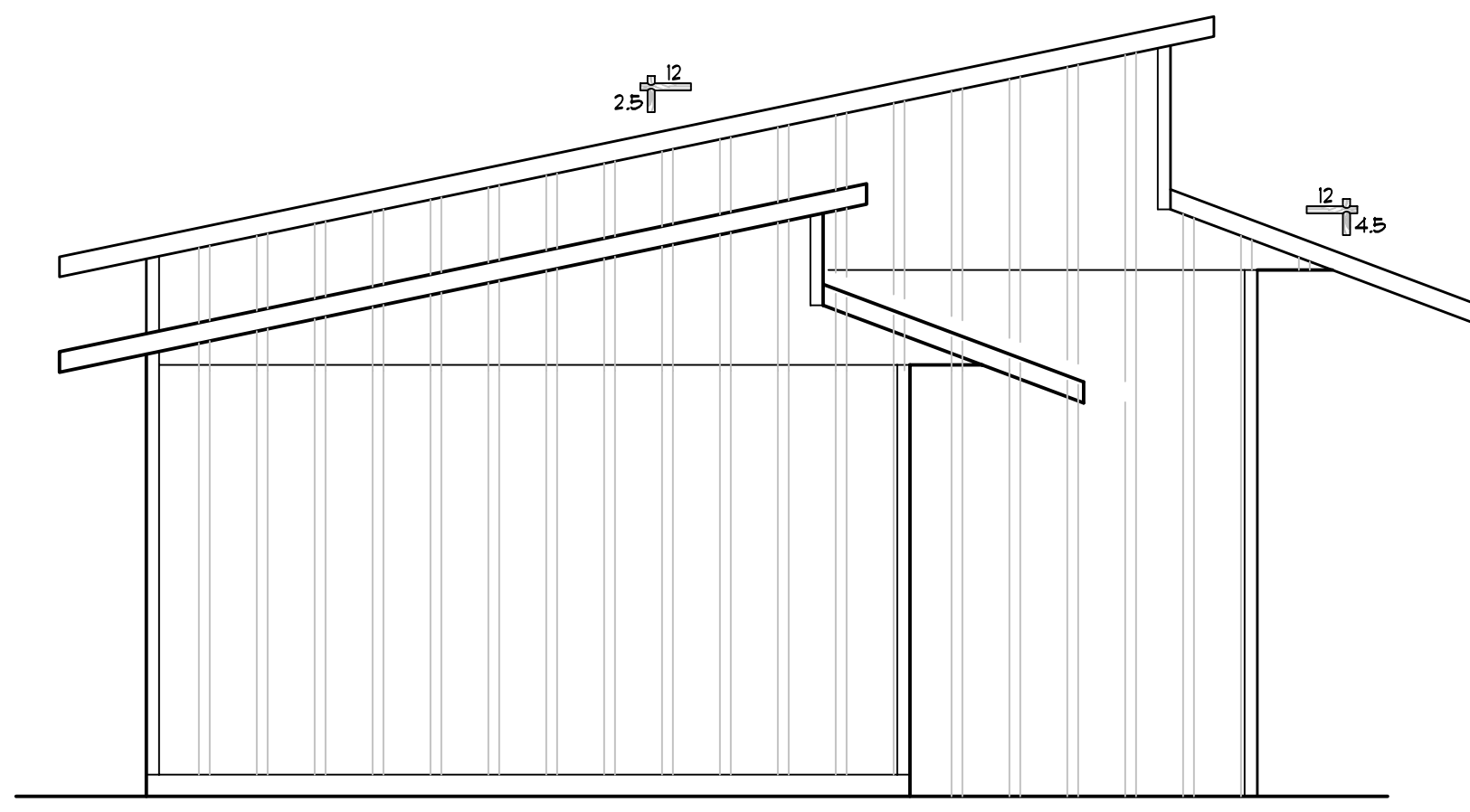

SOUTH ELEVATION PROPOSED





Oregon Historic Site Record

LOCATION AND PROPERTY NAME			
address:	500 W 15th The Dalles, Wasco County	historic name:	Fort Dalles Gardner's Cottage
assoc addresses:		current/other names:	
location descr:		block/lot/tax lot:	
		twshp/rng/sect/qtr sect:	
PROPERTY CHARACTERISTICS			
resource type:	building	height (stories):	1.0
elig evaluation:	undetermined	total elig resources:	
prim constr date:	c.1856	NR Status:	
	second date:	date indiv listed:	
primary orig use:	DOMESTIC: General	orig use comments:	
second orig use:	Government Housing	prim style comments:	
primary style:		sec style comments:	
secondary style:		siding comments:	
primary siding:	Horizontal Board	architect:	
secondary siding:		builder:	
plan type:			
comments/notes:			
8/28/19 HRR Received. TC			
GROUPINGS / ASSOCIATIONS			
Not associated with any surveys or groupings.			
SHPO INFORMATION FOR THIS PROPERTY			
NR date listed:	N/A	106 Project(s):	None
ILS survey date:		Special Assess Project(s):	None
RLS survey date:		Federal Tax Project(s):	None
ARCHITECTURAL / PROPERTY DESCRIPTION			
<i>(Includes expanded description of the building/property, setting, significant landscape features, outbuildings and alterations)</i>			
Refer to scanned documents links.			
HISTORY			
<i>(Chronological, descriptive history of the property from its construction through at least the historic period - preferably to the present)</i>			
Refer to scanned documents links.			
RESEARCH INFORMATION			
Title Records	Census Records	Property Tax Records	Local Histories
Sanborn Maps	Biographical Sources	SHPO Files	Interviews
Obituaries	Newspapers	State Archives	Historic Photographs
City Directories	Building Permits	State Library	
Local Library:		University Library:	
Historical Society:		Other Respository:	
Bibliography:			



STAFF REPORT
Historic Landmarks Commission
HLC 218-24
Tom Giamei, Giamei Properties, LLC

Procedure Type:	Quasi-judicial
Assessor's Map:	Township 1N 13E 3 BD
Tax Lots:	3900
Address:	201 E. 2 nd Street
Zoning District:	Central Business Commercial (CBC) with CBC-1 and CBC-2 Overlay.
Historic Status:	Primary Resource / Eligible/Contributing (per SHPO)
Historic District:	The Dalles Commercial
Existing Use:	American Legion – (a.k.a. Schanno Building)
Prepared by:	Sandy Freund, Senior Planner
Date prepared:	January 15, 2024

REQUEST: Approval to replace four windows on the northeast wall and one door facing Court Street.

A detailed list of the proposed materials for the replacement windows and door is included in the application materials.

NOTIFICATION: Published advertisement in local newspaper, notification to property owners within 100 feet, and State Historic Preservation Office (SHPO).

BACKGROUND: The Schanno Building, c 1892, commonly known as the American Legion Building The Dalles Post #19, is a two-story brick Mediterranean Revival building with basement and masonry foundation, and flat roof with a short parapet wall with built-up coping. Corbelled chimneys cap the roof. The projecting cornice is supported by decorative modillions. A wide frieze extends around the sides of the building. The one over one double-hung wood sash second floor windows are capped with segmental arches. Raised quoins define the corners of the building. A corbelled stringcourse separates the first and second stories.

The building was extensively remodeled c. 1915 with application of concrete over the brick on the second floor. The stucco cladding was scored to resemble ashlar stone blocks. Cast-iron pilaster is visible on the west and south elevations, though some has been removed due to later alterations. The transoms on the front (south) elevation have been boarded over and the storefronts altered. Stairs to the basement and door to the upstairs are located on the ground floor (west elevation). With the exception of extensive ground floor alterations, the building is considered in fair-good condition. The Schanno Building was constructed c. 1892 after a fire destroyed many downtown structures in 1891. The lower floor was used as a merchandise store and the upper floor was used as the ticket office for the Columbia River and Northern Railway, as well as offices for a the law firm of Bennett and Sinnot. Lastly, the upper floor also served as an armory for the 3rd Regiment of the Oregon National Guard.¹

Currently, the ground floor of the building is being used as retail space, and the upper (second) floor used as office space. The proposal is to replace four upper floor windows adjacent to the alley on the northeast side of the building, and replace the existing door facing Court Street.

ANALYSIS: The Historic Landmarks Commission (Commission) is responsible for conducting hearings associated with proposed alterations to historic buildings. The Dalles Municipal Code (TDMC), Title 11 Planning, Chapter 11.12 Historic Resources, provides process as well as established design guidelines to assist the Commission in making these decisions. The purpose of the Commission, Chapter 11.12, and associated review criteria is to:

- *Protect historic and cultural resources from destruction, inappropriate alteration, and incompatible adjacent development;*
- *Stabilize and improve property values in historic districts and City-wide;*
- *Enhance the City's attractiveness to visitors and residents, and stimulate business, industry, and tourism;*
- *Educate The Dalles' citizens and visitors concerning the City's heritage;*
- *Preserve the historic housing stock of The Dalles; and*
- *To comply with The Dalles Comprehensive Plan regarding historic resources under Statewide Planning Goal 5.*

REVIEW CRITERIA:

City of The Dalles Municipal Code, Chapter 11.12 Historic Resources

Article 11.12.070, Section A. Review Criteria

3. *Secretary's Standards. Commission decisions shall be based on the Secretary of the Interior's Guidelines for the Treatment of Historic Properties. Findings #1 - #10 are pertinent standards from the Secretary of the Interior's Guidelines for the Treatment of Historic Properties.*

1. ***A property shall be used for its historic purpose or be placed in a new use that required minimal change to the defining characteristic of the building and its site and environment.***

¹ National Register of Historic Places, Section number 7, page 98)

FINDING #1: Applicant is requesting to retain the historic purpose of the original use, which includes retail on the ground floor and office uses on the second floor. Applicant wishes to replace four windows and one door in order to retain the characteristics of the building. **Criterion met.**

- 2. The historic character of a property shall be retained and preserved. The removal of historic materials or alterations of features and spaces that characterize a property shall be avoided.*

FINDING #2: Applicant requests the replacement of four windows and one door with materials that match the existing building's style. The new windows will feature clear glass and black pine wood sashes. The proposed door will be made of hemlock wood with double-paned glass and oil-rubbed bronze hinges. All replacements will closely match the dimensions and appearance of the original windows and door. The side entry door was replaced during alterations made by the American Legion. The newly proposed door will be of same dimensions, however clearly function with improved accessibility, as a primary entrance for the office space on the second floor. The removal of historic materials or alterations of features and spaces characterizing the building and property is not proposed. **Criterion met with conditions.**

- 3. Each property shall be recognized as a physical record of its time, place, and use. Changes that create a false sense of historical development, such as adding conjectural features or architectural elements from other buildings, shall not be undertaken.*

FINDING #3: Applicant is not proposing exterior modifications that will create a false sense of historical development, with the restoration work intended to bring the building back to its near original state. The new windows (vertical, double-hung sash) and side entry door will use similar wood materials, hardware and design of original items. Staff finds that the proposed work does not create a false sense of historical development as it will not alter any historic feature. **Criterion met.**

- 4. Most properties change over time; those changes that have acquired historic significance in their own right shall be retained and preserved.*

FINDING #4: The building was extensively remodeled c. 1915 with application of concrete over the brick on the second floor. The stucco cladding was scored to resemble ashlar stone blocks. Cast-iron pilaster is visible on the west and south elevations, though some has been removed due to later alterations. The transoms on the front (south) elevation have been boarded over and the storefronts altered. The applicant is not proposing alterations to these existing conditions. Applicant wishes to replace four windows facing the alley and the side-entry door to as near original condition as possible. All original uses (ground floor retail and second floor office space) will be retained and preserved. **Criterion met.**

- 5. Distinctive features, finishes, and construction techniques or examples of craftsmanship that characterize a property shall be preserved.*

FINDING #5: Applicant has provided a list of materials for the replacement of the windows and door using materials and finishes closely matching the original windows and door, making every effort to replicate the appearance of the building. Preservation of the building's overall characteristics will be retained. **Criterion met.**

6. *Deteriorated historic features shall be repaired rather than replaced. Where the severity of deterioration requires replacement of a distinctive feature, the new feature shall match the old in design, color, texture, and other visual qualities and, where possible, materials. Replacement of missing features shall be substantiated by documentary, physical, or pictorial evidence.*

FINDING #6: Applicant states that the four windows are severely damaged, posing both safety and structural risks. The glass is broken and cracked beyond repair, while flaking paint and unstable wooden supports compromise the overall integrity of the window frames. Some sections of the windows have been removed due to deterioration, and two windows have been boarded up or shuttered. Additionally, the door shows significant deterioration and functional issues, including failing hardware and a vertical mullion resulting in a door that may not meet current building code standards. The newly proposed door will match the other doors on the building along E. 2nd Street in both functionality and style. Recent updates to the building were approved in 2019 for a two-phased façade improvement for windows and doors (File # HLC 172-19) Applicant has provided photographs of the windows and door to support the request. **Criterion met.**

7. *Chemical or physical treatments, such as sandblasting that cause damage to historic materials shall not be used. The surface cleaning of structures, if appropriate, shall be undertaken using the gentlest means possible.*

FINDING #7: Applicant is not proposing the use of chemical or physical treatments on the structure. **Criterion not applicable.**

8. *Significant archaeological resources affected by a project shall be protected and preserved. If such resources must be disturbed, mitigation measures shall be undertaken.*

FINDING #8: Applicant is not proposing disturbance of significant resources. **Criterion not applicable.**

9. *New additions, exterior alterations, or related new construction shall not destroy historic materials that characterize the property. The new work shall be differentiated from the old and shall be compatible with the massing, size, scale, and architectural features to protect the historic integrity of the property and its environment.*

FINDING #9: As previously mentioned in FINDING #6, the applicant proposes using materials for the replacement windows and door, including the door's functionality, that closely match the original materials to ensure preservation and compatibility, in size, scale, and architectural features to protect the historic integrity of the building. **Criterion met.**

10. *New additions and adjacent or related new construction shall be undertaken in such a manner that, if removed in the future, the essential form and integrity of the historic property and its environment would be unimpaired.*

FINDING #10: No building additions are proposed at this time. **Criterion not applicable.**

Article 11.12.095 Design Guidelines for The Dalles Commercial Historic District and Trevitt's Addition

F. New Construction and Rehabilitation.

1. *New construction is necessary to accommodate expanding and new needs of a healthy downtown. There are existing gaps in the downtown that should be filled. New construction should maintain the character of The Dalles by not hiding building additions but in making them sympathetic to the historic buildings and town form without imitating past architectural styles.*
2. *Guidelines.*
 - a. *New construction fronting streets should be in keeping with the original architectural character, color, mass, scale and materials of the neighboring buildings (see Subsection D, Secretary of the Interior's Standards for Rehabilitation).*
 - b. *Additions to existing buildings should be in keeping with the original architectural character, color, mass, scale and materials (see Subsection D, Secretary of the Interior's Standards for Rehabilitation).*
 - c. *New construction should fill in gaps in the urban fabric; tight to the sidewalk or vertical edge, reinforcing the enclosure of the street.*
 - d. *Existing additions to historic buildings should be evaluated for their sympathy with the historic building and their contribution to the downtown character.*

FINDING #11: Applicant is replacing four existing windows and one door, with no new construction or additions proposed. **Criterion not applicable.**

G. Streetscape.

1. *The Dalles' downtown is a pedestrian friendly environment resulting from the storefronts, width of sidewalks, and features such as street lights. New construction and rehabilitation should contribute in making downtown The Dalles an inhabitable place that is pleasant for walking, providing a buffer zone of parked cars between automobile traffic and pedestrians, while also reinforcing the rhythm of the street.*
2. *Guidelines.*
 - a. *Landscaping is not recommended because historically there was none.*
 - b. *Historically appropriate street lights should be installed.*
 - c. *Streetlights and other sidewalk elements should be placed so as not to obscure line of vision of automobiles.*
 - d. *Garbage cans are unattractive and should not be part of the streetscape.*
 - e. *A downtown maintenance program should be implemented to keep streets and sidewalks clean.*

FINDING #12: Applicant is not proposing any modifications to the existing streetscape with this proposal. **Criterion not applicable.**

K. Materials.

1. *The sense of cohesiveness and continuity of The Dalles' commercial area derives in part from the consistent use of building materials in building facades. New construction and*

rehabilitation should use appropriate materials that provide scale making a more pedestrian friendly environment.

2. *Guidelines.*

- a. *For building renovations, original materials should be restored wherever possible.*
- b. *When materials need to be replaced for restoration they should be compatible in quality, color, texture, finish and dimension to the original materials (see Subsection D, Secretary of the Interior's Standards for Rehabilitation).*
- c. *New construction should use materials compatible with the historic buildings in quality, color, texture, finish and dimension. Predominant materials of the commercial historic district are:*
 - *brick*
 - *stone*
 - *cast iron*
 - *glazed terra cotta*
 - *cement plaster (stucco)*
- d. *The use of wood for windows is recommended.*
- e. *The use of reflective and smoked glass is prohibited.*
- f. *Whenever possible, the natural color of the materials should be retained.*
- g. *An ordinance prohibiting the painting of brick, unless it is damaged or has already been sandblasted, should be adopted.*
- h. *Sandblasting of brick is prohibited as it severely damages the brick.*
- i. *When painting a building the following color scheme is recommended:*
 - *darkest-window sash*
 - *medium-building*
 - *lightest-trim, detail*

FINDING #13: Applicant is proposing replacement of four severely deteriorated windows on the second floor and one door on Court Street using the recommended wood materials, hardware and design. Windows will be double-hung with wood frame and sashing replicating the original Schanno Building windows as described in the historic inventory documentation. The applicant has stated that the proposed door will be made of wood and glass to match the style of the other doors on the building along E. 2nd Street. Replacing the double door with a single door will not only improve accessibility but also create a wider opening within the existing frame dimensions by removing the vertical mullion. As mentioned in FINDING #6, recent updates to the building were approved in 2019 for a two-phased façade improvement for windows and doors. (File # HLC 172-19). The proposed door will match in both style and materials, the door(s) approved as part of HLC 172-19. The applicant has explained to staff that modifications made by the American Legion rendered the side door unusable as a main entrance to the office space on the second floor. The applicant has provided that all material will be compatible in

quality, color, texture, finish and overall dimensions to the original materials and follow the Secretary of the Interior's Standards for Rehabilitation.

Pursuant to TDMC 11.12.095 (D), historic standards are to be applied to specific rehabilitation projects in a reasonable manner, taking into consideration economic and technical feasibility. **Criterion met with conditions.**

L. Roof Form.

1. *Roof forms contribute to the identity of The Dalles commercial district because historically they were flat with parapets, false fronts, or gables concealed by a parapet or false front, in contrast to the pitched roofs in the residential neighborhoods. New construction and rehabilitation should maintain the commercial nature of the downtown in the articulation of its roof forms along the street edge.*
2. *Guidelines.*
 - a. *Roof forms should be consistent with those commercial buildings of the historic period of downtown.*
 - b. *Parapet and flat roof forms are recommended.*
 - c. *Pitched roof forms associated with residential structures are not recommended, unless concealed by a parapet.*
 - d. *Detailing of the parapets with patterned or relief cornices and stepping is highly recommended.*

FINDING #14: No modifications to the existing roof line are proposed with this application. **Criterion not applicable.**

M. Commercial Front.

1. *The continuous commercial fronts of downtown The Dalles make a consistent, pedestrian friendly backdrop for a wide variety of businesses. The storefront is predominantly made up of glazing with only structure and decoration revealed. The upper stories consist mostly of wall with discreet window openings. New construction and rehabilitation should maintain the continuity of the multi-story buildings and the clear distinction between storefront and upper floor office or residences through facade treatment and articulation.*
2. *Guidelines.*
 - a. *Primary entrances should be recessed, glazed and oriented to the street rather than to a rear or interior alley.*
 - b. *Tiled floors are highly effective in marking the recessed entrance.*
 - c. *The use of large, clear plate glass for display windows incorporated with transom windows is recommended.*
 - d. *The use of vertical, double-hung windows; either singly or in groups is recommended on the upper levels.*

- e. Window bulkheads of the historic type are recommended.*
- f. Identify and retain fragments such as earlier window systems and no longer used door locations which evoke a sense of the building's history.*
- g. The use of historic photographs for reference is recommended.*
- h. Development and adoption of a Facade Improvement Plan is recommended*

FINDING #15: The proposed rehabilitation will not alter the existing building and will maintain the continuity of the multi-story building with a clear distinction between the ground floor retail/storefront and second floor discrete office space through the existing facade articulation. The proposed second floor window replacement is along the alley, opposite of 2nd Street, and the door replacement is along Court Street. The alleyway does not experience pedestrian traffic to the same extent as 2nd Street. The applicant intends to use vertical, double-hung windows with wood frame and sashing, and wood and glass for the new replacement door to match the previous approval in 2019 (File # HLC 172-19).

Criterion met.

N. Awnings.

1. Awnings provide a "ceiling" for pedestrian traffic which helps to give a sense of enclosure to the street and protection from the elements. New construction and rehabilitation should maintain the horizontal datum line along the street, resulting from awnings which enliven the street, making it pedestrian friendly.

2. Guidelines.

a. The use of historic photographs is recommended for reference in replacement of awnings and canopies.

b. Awnings and canopies should fit within window bays so as not to detract from architectural features of the building.

c. Awnings and canopies should not obscure transom windows above display windows.

d. Retractable fabric awnings were used historically and are recommended, as they add variety to the streetscape because they can be adjusted to varying conditions, such as light and weather.

e. Awnings should have a slope of no more than 45 degrees.

f. The color of the awning should be compatible with the building.

g. Flat, horizontal metal canopies suspended by chains or rods, if original, should be used as they provide cover for pedestrians and shade within the store.

h. The use of internally illuminated, plastic, barrel awnings are prohibited as they detract from architectural features with incompatible materials that are out of scale.

FINDING #16: Applicant is not proposing the installation of awnings. **Criterion not applicable.**

RECOMMENDATION: Based on the application materials and findings demonstrating compliance with the applicable criteria, Staff finds this proposal meets the standards of the

Secretary of the Interior and The Dalles Municipal Code, Title 11- Planning, Chapter 11.12 Historic Resources and **recommends *approval* of Historic Landmarks Commission No. 218-24 subject to the following conditions of approval.** This approval is based on the Applicant's written narrative, and supplemental application materials received by December 20, 2024.

Conditions of Approval:

1. Work shall be completed in substantial conformance to the pictures and proposals as submitted, reviewed and/or modified.
2. The replacement door on Court Street shall compliment the building and meet applicable design standards. If building code requirements are contrary to the design standards, the applicant will need to work with both the City and Building Codes to ensure that the materials are complimentary to the historic building and the design guidelines.
3. The applicant shall submit plans for a building permit to City of The Dalles and then Wasco County Building Codes.
4. If historical artifacts over 75 years old are found on the site in relation to the proposed project, resulting from land disturbance, excavation, or grading activities, all applicable state laws and regulations shall be followed in accordance with the guidance of the State Archeologist.
5. The applicant is required to notify the Community Development Department of any alteration of approved plans.



City of The Dalles
 Community Development Dept
 313 Court Street
 The Dalles, OR 97058
 (541) 296-5481, ext. 1125
 www.thedalles.org

Application #: HLC 218-24
 Filing Fee: \$85.00
 Receipt #: 875633
 Deemed Complete: _____
 Ready to Issue: _____
 Date Issued: _____

Received: 12/20/2025

Historic Landmarks Application

This application is required for all new construction, modifications, and/or alterations to the exterior of certified historic structures and all structures within certified historic districts and reviewed by the City of The Dalles' Historic Landmarks Commission. The review criteria for each application are the Secretary of the Interior's Standards. These standards have been adopted by The Dalles Municipal Code Chapter 11.12 Historic Resources as local review criteria.

Applicant

Name: Tom Gramei
 Address: 201 E. 2nd Street
The Dalles, OR 97058
 Phone #: 607-753-7867
 Email: tag8373@gmail.com

Legal Owner (if different than Applicant)

Name: _____
 Address: _____
 Phone #: _____
 Email: _____

Property Information

Address: 201 E. 2nd Street
 Zone: CBC
 Current Use: Commercial

Map and Tax Lot: 1N 13E 3 BD 3900

List any known archeological resources on site: None

Department Use Only

Historic Name (if any): _____
 Year(s) Built: _____ Historic Building/Site: Yes No
 Historic Classification: _____
 Historic District: Trevitt's Addition Downtown Commercial

Project Information

- New Construction
- Expansion/Alteration
- Demolition
- Landmark Designation

Briefly describe the proposed project:

we are seeking approval to replace four windows on the alley-facing side of the historic building located at 201 E. 2nd St. The windows are in disrepair and need replacement due to current conditions. We are also seeking approval to replace the side door on Court Street.

Will the use change as a result of this application? Yes No

Please submit the following information with this application:

- Narrative #1: Description of the project consistent with the Secretary of Interior’s Standards for Rehabilitation (page ?)
- Narrative #2: Explanation of the project consistent with the associated project type (pages ?):
 - Landmark Designation (#2-A)
 - Alterations/New Construction/Relocation (#2-B)
 - Demolition (#2-C)
- Narrative #3: Description of the project consistent with the associated district design standards: New Construction and Alteration (page ?)
 - The Dalles Commercial Historic District (#3-A)
 - Trevitt’s Addition (#3-B)
- Narrative #4, Signs (if applicable): Description of the project consistent with the associated historic sign guideline criteria (page ?)
- Elevation drawings (existing vs. proposed)
- Current color photographs of the structure and/or site
- List of all proposed materials/colors (product brochures recommended)
- Site Plan (drawn to scale)
- Historic photographs/documentation of the structure and/or site (encouraged)
- Copy of all associated Historic Inventory information

Signature of Applicant

Signature of Property Owner

[Handwritten Signature]

12/18/24

[Handwritten Signature]

12/18/24

Date

Date

Proposal to Replace Windows and Side Door at 201 E. 2nd Street, The Dalles, Oregon

Project Overview:

We are seeking approval to replace four windows on the alley-facing side of the historic building located at 201 E. 2nd Street. These windows are currently in a state of significant disrepair and pose both safety and structural concerns. Additionally we are seeking approval to replace the side entrance door.

Current Condition

The existing windows and door are characterized by the following issues:

- Broken and cracked glass, creates a safety hazard.
- Flaking paint and unstable wooden supports, compromising the integrity of the structure.
- Non-functioning hardware, rendering the windows unusable.
- Some portions of the windows previously removed due to deterioration.
- Two windows are boarded up and 2 are closed with shutters.
- The door has significant deterioration and function issues including failing hardware connections and multiple patches.

Proposed Work

To address these concerns, we propose replacing the existing windows and door with new wooden options that closely match the dimensions and appearance of the originals. The replacement windows and door will adhere to the following specifications:

- Constructed from wood to maintain the historic character of the building.
- Closely matching the original dimensions to ensure compatibility with the existing structure.
- Designed to meet current safety standards while preserving the aesthetic integrity of the building.

Commitment to Historic Preservation

Our proposal is guided by a commitment to preserving the historic character of the building. Every effort will be made to replicate the appearance of the original windows and door while ensuring the safety and functionality of the replacements.

We respectfully request the Commission's review and approval of this project. Thank you for your consideration.

Sincerely,
Tom and Lindsey Giamei

201 E. 2nd Street

The Dalles, OR 97058

Paula Webb

Subject: FW: Additional Narrative re: Door

From: thomas giamei <tag8373@gmail.com>

Sent: Monday, January 13, 2025 4:01 PM

To: Sandy Freund <sfreund@ci.the-dalles.or.us>

Subject: Re: Use of the Schanno building

WARNING: Email from external source. Links and attachments could pose security risks. Investigate sender and think before you click.

Hello Sandy,

Thanks for the call -

Below is a Summary:

Door on Court Street -

We are seeking to replace the door on Court Street with the wood door option line item 1 on the historic packet. This door will allow for a wider entrance for occupants opposed to the current limited double door in place. The current door is suspected to have been replaced during the American Legion remodel. This is evident from the boarded-up upper portion of the door frame. The proposed new wood entryway door will be the access for the offices and the downstairs space. There is no other access options and a door with glass and wide access is preferred to honor the history of the building. The door would also mirror the current doors installed on 2nd street that were previously approved by the HLC.

Windows in Ally -

We are seeking to replace the 4 windows on the ally side of the building. The windows are currently shuttered and boarded up respectively. The only remaining portions of the windows are in disrepair and none of which would allow for a safe installation. We are proposing wood windows to replace each of the windows. They will be painted black on the exterior to match the remaining portion of the building. Please refer to the submittal packet for additional details related to the windows.

Tom

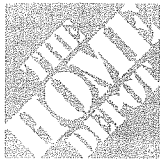

The Home Depot Special Order Quote

Customer Agreement #: H4026-259970

Printed Date: 12/9/2024

Customer: THOMAS GIAMEI
Address: 1707 LINCOLN WAY
 THE DALLES, OR 97058
Phone: 610-216-0875
Email: TAG8373@GMAIL.COM

Store: 4026
Associate: TIM
Address: 3600 W 6th Street
 The Dalles, OR 97058
Phone: (541)296-7006

Pre-Savings Total: \$4,694.00
Total Savings: (\$0.00)
Pre-Tax Price: \$4,694.00

All prices are subject to change. Customer is responsible for verifying product selections. The Home Depot will not accept returns for the below products.

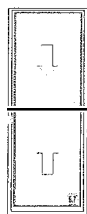
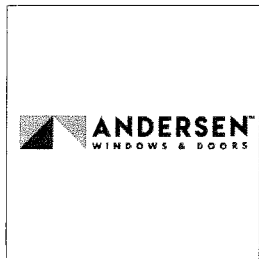

RO Size = 36 1/8" x 92 7/8"
Unit Size = 35 5/8" x 92 7/8"

Catalog Version 265

Line	Description	Unit Price	Quantity	Subtotal	Savings	Total
100-1	400 Series Double-Hung Equal Sash, AA, Rough Opening 36.125 x 92.875, 35.625 x 92.875, Black w/Black Sash / Frame:Pine White - Painted Panel:Pine White - Painted	\$1,186.83	2	\$2,373.66	\$0.00	\$2,373.66
100-2	Optional Lock Hardware 1: TW Traditional Black PN:9069434 Version:10/18/2024	\$16.76	2	\$33.52	\$0.00	\$33.52
100-3	Insect Screen 1: 400 Series Double-Hung, TW21076 Full Screen Aluminum Black PN:9128573 Version:10/18/2024	\$103.23	2	\$206.46	\$0.00	\$206.46
Unit Total:		\$1,306.82		\$1,306.82	\$0.00	\$1,306.82

Begin Line 100 Descriptions

--- Line 100-1 ---

400 Series Double-Hung
 Overall Rough Opening = 36 1/8" x 92 7/8"
 Overall Unit = 35 5/8" x 92 7/8"
 Installation Method = Nailing Flange
 Installation Zip Code = 97058
 U.S. ENERGY STAR® Climate Zone = Northern
 Search by Unit Code = No
 Standard Width = TW210XX - RO: 36 1/8" | UNIT: 35 5/8"
 Standard Height = XX76 - RO: 92 7/8" | UNIT: 92 7/8"
 Frame Width = 35 5/8
 Frame Height = 92 7/8
 Unit Code = TW21076
 Frame Option = Installation Flange
 Venting / Handing = AA
 Exterior Frame Color = Black

Jamb Liner Color = White
 Glass Construction Type = Dual Pane
 Glass Option = Low-E4 HeatLock
 High Altitude Breather Tubes = No
 Glass Strength = Standard
 Specialty Glass = None
 Gas Fill = Argon
 Glass / Grille Spacer Color = Stainless None
 DP/PG Upgrade = No
 Sash Lift Type = None
 Lock Hardware Style = Traditional
 Number of Sash Locks = 1
 Lock Hardware Color/Finish = Black
 Window Opening Control Device = No
 Insect Screen Type = Full Screen
 Insect Screen Material = Aluminum

Stool Option = None
 Installation Material Options = No
 Re-Order Item = No
 Room Location =
 Unit U-Factor = 0.26
 Unit Solar Heat Gain Coefficient (SHGC) = 0.31
 Unit CPD Number = AND-N-24-07369-00001
 U.S. ENERGY STAR® Certified = No
 Clear Opening Width = 31.875
 Clear Opening Height = 41.75
 Clear Opening Area = 9.26
 Optional Lock Hardware 1 Part Number = 9069434
 Insect Screen 1 Part Number = 9128573
 SKU = 407679
 Vendor Name = S/O ANDERSEN LOGISTICS
 Vendor Number = 60509030

Exterior Sash / Panel Color = Black
 Interior Frame Wood Species = Pine
 Interior Frame Finish Color = White - Painted
 Interior Sash / Panel Wood Species = Pine
 Interior Sash / Panel Finish Color = White - Painted

Insect Screen Color = Black
 Exterior Trim Style = None
 Extension Jamb Type = None

Customer Service = (888) 888-7020
 Catalog Version Date = 10/18/2024
 SKU Description = S/O 400S TILT/WASH

---- Lines 100-2 to 100-3 have the same description as line 100-1 ----

End Line 100 Descriptions

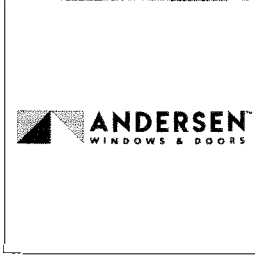

Catalog Version 265

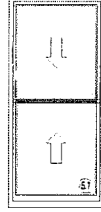

RO Size = 36 1/8" x 76 7/8"
 Unit Size = 35 5/8" x 76 7/8"

Line	Unit Price	Description	Unit Price	Quantity	Total Price	Total Price
200-1	\$960.00	400 Series Double-Hung Equal Sash, AA, Rough Opening 36.125 x 76.875, 35.625 x 76.875, Black w/Black Sash / Frame:Pine White - Painted Panel:Pine White - Painted	\$960.00	1	\$960.00	\$960.00
200-2	\$16.76	Optional Lock Hardware 1: TW Traditional Black PN:9069434 Version:10/18/2024	\$16.76	1	\$16.76	\$16.76
200-3	\$72.02	Insect Screen 1: 400 Series Double-Hung, TW21062 Half Screen Aluminum Black PN:9128951 Version:10/18/2024	\$72.02	1	\$72.02	\$72.02
Unit 100 Total:			\$1,048.78		\$1,048.78	\$1,048.78

Begin Line 200 Descriptions

---- Line 200-1 ----

400 Series Double-Hung
 Overall Rough Opening = 36 1/8" x 76 7/8"
 Overall Unit = 35 5/8" x 76 7/8"
 Installation Method = Nailing Flange
 Installation Zip Code = 97058
 U.S. ENERGY STAR® Climate Zone = Northern
 Search by Unit Code = No
 Standard Width = TW210XX - RO: 36 1/8" | UNIT: 35 5/8"
 Standard Height = XX62 - RO: 76 7/8" | UNIT: 76 7/8"
 Frame Width = 35 5/8"
 Frame Height = 76 7/8"
 Unit Code = TW21062
 Frame Option = Installation Flange
 Venting / Handing = AA
 Exterior Frame Color = Black
 Exterior Sash / Panel Color = Black
 Interior Frame Wood Species = Pine
 Interior Frame Finish Color = White - Painted
 Interior Sash / Panel Wood Species = Pine
 Interior Sash / Panel Finish Color = White - Painted

Jamb Liner Color = White
 Glass Construction Type = Dual Pane
 Glass Option = Low-E4 HeatLock
 High Altitude Breather Tubes = No
 Glass Strength = Standard
 Specialty Glass = None
 Gas Fill = Argon
 Glass / Grille Spacer Color = Stainless None
 DP/PG Upgrade = No
 Sash Lift Type = None
 Lock Hardware Style = Traditional
 Number of Sash Locks = 1
 Lock Hardware Color/Finish = Black
 Window Opening Control Device = No
 Insect Screen Type = Half Screen
 Insect Screen Material = Aluminum
 Insect Screen Color = Black
 Exterior Trim Style = None
 Extension Jamb Type = None

Stool Option = None
 Installation Material Options = No
 Re-Order Item = No
 Room Location =
 Unit U-Factor = 0.26
 Unit Solar Heat Gain Coefficient (SHGC) = 0.31
 Unit CPD Number = AND-N-24-07369-00001
 U.S. ENERGY STAR® Certified = No
 Clear Opening Width = 31.875
 Clear Opening Height = 33.75
 Clear Opening Area = 7.259
 Optional Lock Hardware 1 Part Number = 9069434
 Insect Screen 1 Part Number = 9128951
 SKU = 407679
 Vendor Name = S/O ANDERSEN LOGISTICS
 Vendor Number = 60509030
 Customer Service = (888) 888-7020
 Catalog Version Date = 10/18/2024
 SKU Description = S/O 400S TILT/WASH H

---- Lines 200-2 to 200-3 have the same description as line 200-1 ----

End Line 200 Descriptions

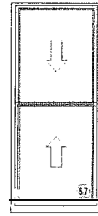
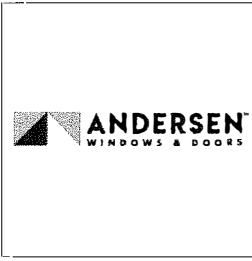

RO Size = 34 1/8" x 76 7/8"
 Unit Size = 33 5/8" x 76 7/8"

Catalog Version 265

Line Number	Description	Unit Price	Ext Price	Quantity	Ext Price	Ext Price
300-1	400 Series Double-Hung Equal Sash, AA, Rough Opening 34.125 x 76.875, 33.625 x 76.875, Black w/Black Sash / Frame:Pine White - Painted Panel:Pine White - Painted	\$944.10	\$944.10	1	\$0.00	\$944.10
300-2	Optional Lock Hardware 1: TW Traditional Black PN:9069434 Version:10/18/2024	\$16.76	\$16.76	1	\$0.00	\$16.76
300-3	Insect Screen 1: 400 Series Double-Hung, TW2862 Half Screen Aluminum Black PN:9128962 Version:10/18/2024	\$70.72	\$70.72	1	\$0.00	\$70.72
Unit 300 Total		\$1,031.58	\$1,031.58		\$0.00	\$1,031.58

Begin Line 300 Descriptions

---- Line 300-1 ----

400 Series Double-Hung
 Overall Rough Opening = 34 1/8" x 76 7/8"
 Overall Unit = 33 5/8" x 76 7/8"
 Installation Method = Nailing Flange
 Installation Zip Code = 97058
 U.S. ENERGY STAR® Climate Zone = Northern
 Search by Unit Code = No
 Standard Width = TW28XX - RO: 34 1/8" | UNIT: 33 5/8"
 Standard Height = XX62 - RO: 76 7/8" | UNIT: 76 7/8"
 Frame Width = 33 5/8
 Frame Height = 76 7/8
 Unit Code = TW2862
 Frame Option = Installation Flange
 Venting / Handing = AA
 Exterior Frame Color = Black
 Exterior Sash / Panel Color = Black
 Interior Frame Wood Species = Pine
 Interior Frame Finish Color = White - Painted
 Interior Sash / Panel Wood Species = Pine
 Interior Sash / Panel Finish Color = White - Painted

Jamb Liner Color = White
 Glass Construction Type = Dual Pane
 Glass Option = Low-E4 HeatLock
 High Altitude Breather Tubes = No
 Glass Strength = Standard
 Specialty Glass = None
 Gas Fill = Argon
 Glass / Grille Spacer Color = Stainless None
 DP/PG Upgrade = No
 Sash Lift Type = None
 Lock Hardware Style = Traditional
 Number of Sash Locks = 1
 Lock Hardware Color/Finish = Black
 Window Opening Control Device = No
 Insect Screen Type = Half Screen
 Insect Screen Material = Aluminum
 Insect Screen Color = Black
 Exterior Trim Style = None
 Extension Jamb Type = None

Stool Option = None
 Installation Material Options = None
 Re-Order Item = No
 Room Location =
 Unit U-Factor = 0.26
 Unit Solar Heat Gain Coefficient (SHGC) = 0.31
 Unit CPD Number = AND-N-24-073E 1-00001
 U.S. ENERGY STAR® Certified = No
 Clear Opening Width = 29.875
 Clear Opening Height = 33.75
 Clear Opening Area = 6.804
 Optional Lock Hardware 1 Part Number = 9069434
 Insect Screen 1 Part Number = 9128962
 SKU = 407679
 Vendor Name = S/O ANDERSEN LOGISTICS
 Vendor Number = 60509030
 Customer Service = (888) 888-7020
 Catalog Version Date = 10/18/20, 1
 SKU Description = S/O 400S TILTWASH

---- Lines 300-2 to 300-3 have the same description as line 300-1 ----

End Line 300 Descriptions











The Home Depot Special Order Quote

Customer Agreement #: H4026-263055

Printed Date: 12/20/2024

Customer: THOMAS GIAMEI
Address: 1707 LINCOLN WAY
 THE DALLES, OR 97058
Phone: 610-216-0875
Email: TAG8373@GMAIL.COM

Store: 4026
Associate: ANDREW
Address: 3600 W 6th Street
 The Dalles, OR 97058
Phone: (541)296-7006

Pre-Savings Total: \$15,392.93
Total Savings: (\$0.00)
Pre-Tax Price: \$15,392.93

All prices are subject to change. Customer is responsible for verifying product selections. The Home Depot will not accept returns for the below products.

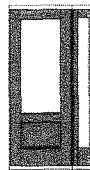

Unit 1: Door Call Width = 3/0
 Unit 1: Call Height = 8/0
 Unit 1: Door Frame Width = 37 1/2
 Unit 1: Height = 97 5/8
 Unit 2: Sidelite Call Width = 1/0
 Unit 2: Call Height = 8/0
 Unit 2: Sidelite Frame Width = 13
 Unit 2: Height = 97 5/8

Catalog Version 315

Line Number	Item Summary	Room Location	Was Price	Now Price	Quantity	Total Savings	Total Price
100-1	Entry Door 50.5 x 97.625		\$4,996.93	\$4,996.93	1	\$0.00	\$4,996.93
Unit 100 Total:			\$4,996.93	\$4,996.93		\$0.00	\$4,996.93

Begin Line 100 Description

---- Line 100-1 ----

Exterior Rogue Valley Door Special Order Entry Door 50.5 x 97.625
 Unit 1: Door Call Width = 3/0
 Unit 1: Call Height = 8/0
 Unit 1: Door Frame Width = 37 1/2
 Unit 1: Height = 97 5/8
 Unit 2: Sidelite Call Width = 1/0
 Unit 2: Call Height = 8/0
 Unit 2: Sidelite Frame Width = 13
 Unit 2: Height = 97 5/8
 Unit 1: Region = Wilsonville
 Unit 1: 20 Min Fire Rating = No
 Unit 1: Door Handing = Left Hand Inswing (1A)
 Unit 2: Region = Wilsonville
 Unit 2: Door Handing = Left Hand Inswing (1A)
 Unit 1: Glass Design = 3/4 Lite (Insulated)
 Unit 1: Model Number = 4621
 Unit 1: Door Category = Clear Glass Doors
 Unit 1: Material = Wood
 Unit 1: Wood Species = Hemlock
 Unit 1: Door Thickness = 1 3/4"
 Unit 2: Material = Wood
 Unit 2: Door Thickness = 1 3/4"
 Glass Shape = 3/4 Rectangle
 Glass Collection = Clear Glass Collection
 Door Style = 1 Panel 1 Lite (4621)
 Glass Name = Clear IG
 Caming = N/A

Glass Thickness = 5/8"
 Door Sticking Option = Ovolo
 Door Raised Moulding Type = N/A
 Panel Option = 1-3/8" HRP
 Stile Width = 5-1/2"
 Wood Veneer Thickness = 1/16" Veneer Rogue Standard
 Sidelite Model Number = 4701 SL
 Sidelite Material = Wood
 Sidelite Wood Species = Hemlock
 Sidelite Glass Collection = Clear Glass Collection
 Sidelite Shape = Full Lite (4701 SL)
 Sidelite Glass Name = Clear IG
 Sidelite Caming = N/A
 Sidelite Grille Type = N/A
 Sidelite Low-E = No
 Sidelite Glass Thickness = 5/8"
 Sidelite Sticking Option = Ovolo
 Sidelite Raised Moulding Type = N/A
 Sidelite Panel Option = N/A
 Door Protection Cover = Door Protection Cover
 Lock System Type = Lock Prep Only - No Hardware
 Door Bore = Double Bore (Lockset w/ Deadbolt)
 Bore Backset = 2-3/8"
 Edge Prep = Mortise (Radius Corner)
 Unit 1: Jamb Species = Hemlock (Rogue)
 Unit 1: Jamb Width = 5 1/4"
 Unit 1: Jamb Type = Single Rab Kerfed w/ RV1310

Unit 1: Exterior Trim = RV180 Brickmould
 Unit 1: Exterior Trim Application = Apply Brickmould
 Unit 1: Sill = Bronze Tru-D Composite Adjustable Sill
 Unit 1: Sill Cover = No Thank You
 Unit 2: Jamb Species = Hemlock (Rogue)
 Unit 2: Jamb Width = 5 1/4"
 Unit 2: Weatherstrip = Bronze Weatherstrip
 Unit 2: Jamb Machining = No Machining
 Unit 2: Sill = Bronze Tru-D Composite Adjustable Sill
 Unit 2: Sill Cover = No Thank You
 Hinge Finish = Oil-Rubbed Bronze (US10B)
 Hinge Type = Ball-Bearing
 Hinge Shape = 5/8" Radius
 Unit 1: Screen Door = No Thank You
 Unit 1: Weather Protection = No Thank You
 Unit 2: Weather Protection = No Thank You
 Room Location =
 Unit 1: SKU = 546973
 Unit 1: Vendor Name = OrePac
 Unit 1: Vendor Number = 60549142
 Unit 1: Customer Service = 877-4-OrePac
 Unit 1: Catalog Version Date = 11/26/2024
 Unit 1: SKU Description = S/O OREPAC CSTM EXT WOOD DOOR 42-56D
 Unit 1: THD Client Group = OrePac - All Stores US

Grille Type = N/A
 Low-E Glass = No
 Glass Size = N/A

Mull Post
 Unit 1: Weatherstrip = Bronze Weatherstrip
 Unit 1: Jamb Machining = No Machining

Unit 2: Vendor Name = OrePac
 Unit 2: Vendor Number = 60549142
 Unit 2: Customer Service = 877-4-OrePac
 Unit 2: Catalog Version Date = 11/26/2024
 Unit 2: THD Client Group = OrePac - All Stores US

End Line 100 Description



Unit 1: Door Frame Width = 36.75,
 Frame Height = 97.625
 Unit 2: Sidelite Frame Width = 12.75,
 Frame Height = 97.625

Catalog Version 377

Line Number	Item Summary	Room Location	Was Price	Now Price	Quantity	Total Savings	Total Price
200-1	Exterior Fiberglass Entry Door 50.5 x 97.625 Fiber-Classic Oak Collection 8' 3/4 Lite 1 Panel Stain Both Sides		\$5,753.33	\$5,753.33	1	\$0.00	\$5,753.33
Unit 200 Total:			\$5,753.33	\$5,753.33		\$0.00	\$5,753.33

Begin Line 200 Description

---- Line 200-1 ----

Exterior Fiberglass Entry Door 50.5 x 97.625
 Unit 1: Door Frame Width = 36.75, Frame Height = 97.625
 Unit 2: Sidelite Frame Width = 12.75, Frame Height = 97.625
 Cut Down = No
 Configuration = Exterior Fiberglass - Single with 1 Sidelite, Fire Rating = No, Impact Rated = No, Sidelite Type = Standard
 Door Swing = Inswing, Handing = Left Hand Inswing (1A)
 Slab Width = 3'0", Slab Height = 8' 0", Glass Layout = 3/4 Lite, Material = Fiber-Classic Oak Collection, Panel Design = 8' 3/4 Lite 1 Panel, Glass Size = 22x64-8/0, Glass Type = Clear Glass, Grille Style = None, Glass Style = Clear, Grille Color = None, Low-E = Yes, Caming Option = None, Frame Type = Scroll Frame, Model = 81943P-ADVSLE
 Sidelite Slab Width = 12", Sidelite Slab Height = 8' 0", Material = Fiber-Classic Oak Collection, Glass Layout = 3/4 Lite, Panel Design = 8' 3/4 Lite Sidelite 1 Panel, Glass Size = 7x64-8/0, Glass Type = Clear Glass, Grille Style = None, Glass Style = Clear, Grille Color = None, Low-E = Yes, Caming Option = None, Frame Type = Scroll Frame, Model = 81943PSL-ADVSLE

Unit 1: Prefinish Options = Prefinish Door and Frame, Door Prefinishing = Stain Both Sides, Exterior Stain = Barley, Interior Stain = Barley, Frame Prefinishing Options = Stain Both Sides, Exterior Frame Stain = Barley, Interior Frame Stain = Barley
 Unit 2: Prefinish Options = Prefinish Door and Frame, Sidelite Prefinish Matches Door = Yes, Sidelite Prefinishing = Stain Both Sides, Sidelite Exterior Stain = Barley, Sidelite Interior Stain = Barley, Frame Prefinishing Options = Stain Both Sides, Exterior Frame Stain = Barley, Interior Frame Stain = Barley
 Unit 1: Jamb Depth = 5 1/4", Jamb Material = Composite Woodgrain Tan, Jamb Machining = None, Sill Type = Composite Adjustable, Sill Finish = Bronze, Weather Protection = No, Protective Sill Cover = Yes, Weatherstrip Option = Compression Bronze
 Unit 2: Jamb Depth = 5 1/4", Jamb Material = Composite Woodgrain Tan, Jamb Machining = None, Sill Type = Composite Adjustable, Weather Protection = No, Protective Sill Cover = Yes
 Unit 1: Lock System Type = Lock Prep Only - No Hardware, Door Bore = Double Bore 2 3/8" Backset, Deadbolt Strike Jamb Prep = 1" X 2-1/4" (Standard), Edge Prep = Mortise (Radius Corner), Hinge_Finish = Oil-Rubbed Bronze (US10B), Hinge_Type = Ball-Bearing, Hinge_Shape = 5/8" Radius, Door Protection Cover = Door Protection Cover
 Unit 2: Door Protection Cover = Door Protection Cover
 Exterior Casing = Brickmould, Exterior Casing Application = Apply Brickmould
 Unit 1: Door U-Factor = 0.28, Door Solar Heat Gain Coefficient = 0.18, Energy Star Rated = South Central and Southern Zones Only

Unit 2: Sidelite U-Factor = 0.20, Sidelite Solar Heat Gain Coefficient = 0.06, Energy Star Rated = No
 Room Location =
 SKU = 853782, Vendor Name = OrePac, Vendor Number = 60549142, Customer Service = 877-467-3722, Catalog Version Date = 12/10/2024, SKU Description = S/O OREPAC TTRU CSTM STND FG 42-49D
 Handleset Line Item = No
 Unit 1: AllowDefault::Sidelite Prefinish Matches Door = Initializing
 Unit 2: AllowDefault::Sidelite Prefinish Matches Door = Yes
 Mull Type = Continuous - Standard

End Line 200 Description

Oregon Historic Site Record

LOCATION AND PROPERTY NAME			
address:	201-205 E 2nd St The Dalles, Wasco County	historic name:	Schanno Building
assoc addresses:		current/other names:	American Legion Bldg; Post 19 Legion Hall
location descr:		block/lot/tax lot:	
		twنشp/rng/sect/qtr sect:	1N 13E 3
PROPERTY CHARACTERISTICS			
resource type:	Building	height (stories):	2.0
elig evaluation:	eligible/contributing	total elig resources:	
prim constr date:	1892	second date:	1915
		NR Status:	Listed in Historic District
		date indiv listed:	
primary orig use:	Department Store	orig use comments:	
second orig use:	SOCIAL: General	prim style comments:	
primary style:	Mediterranean Revival	sec style comments:	
secondary style:		siding comments:	
primary siding:	Brick:Other/Undefined	architect:	
secondary siding:	Cast Iron	builder:	
plan type:			
comments/notes:			
GROUPINGS / ASSOCIATIONS			
Survey/Grouping Included In:	Type of Grouping	Date Listed	Date Compiled
The Dalles Commercial Historic District	Listed Historic District	11/04/1986	
SHPO INFORMATION FOR THIS PROPERTY			
NR date listed: N/A	Special Assessment		106 Project(s): None
ILS survey date:	Status Active	Term 1st	Federal Tax Project(s): None
RLS survey date:		End Yr 2030	
ARCHITECTURAL / PROPERTY DESCRIPTION			
<i>(Includes expanded description of the building/property, setting, significant landscape features, outbuildings and alterations)</i>			
Refer to scanned documents links.			
HISTORY			
<i>(Chronological, descriptive history of the property from its construction through at least the historic period - preferably to the present)</i>			
Refer to scanned documents links.			
RESEARCH INFORMATION			
Title Records	Census Records	Property Tax Records	Local Histories
Sanborn Maps	Biographical Sources	SHPO Files	Interviews
Obituaries	Newspapers	State Archives	Historic Photographs
City Directories	Building Permits	State Library	
Local Library:		University Library:	
Historical Society:		Other Respository:	
Bibliography:			



CITY of THE DALLES

313 COURT STREET
THE DALLES, OREGON 97058

(541) 296-5481 ext. 1125
COMMUNITY DEVELOPMENT DEPARTMENT

HISTORIC LANDMARKS RESOLUTION NO. 203-25

Adopting The Dalles Historic Landmarks Commission Application #217-24, Denise Dietrich-Bokum, FDMAH Foundation. This application is for a Historic Landmarks Commission hearing to gain approval for the demolition and new replacement construction of a vehicle storage building to house historic wagons. The property is located at 500 W. 15th Street, The Dalles, Oregon, and further described as 1N 13E DB tax lot 10400. The subject site is the location of the Fort Dalles Surgeon's Quarters, which includes the Gardener's Cottage, c 1856, and two vehicle storage buildings, which were added in 1964. The subject property is zoned P/OS – Parks and Open Space.

RECITALS:

- A. The Historic Landmarks Commission of the City of The Dalles has, on January 22, 2025 conducted a public hearing to consider the above request.
- B. A Staff Report was presented, stating findings of fact and conclusions of law.
- C. Staff Report 217-24 and the minutes of the January 22, 2025 hearing, upon approval, provide the basis for this resolution and are herein attached by reference.

II. RESOLUTION: Now, therefore, be it FOUND, DETERMINED, and ORDERED by the Historic Landmarks Commission of the City of The Dalles as follows:

- A. In all respects as set forth in Recitals, Part "I" of this resolution.
- B. Historic Landmarks Review 217-24, **Denise Dietrich-Bokum, FDMAH Foundation**, is ***approved*** with the following conditions:

Conditions of Approval:

1. Work shall be completed in substantial conformance to the pictures and proposals as submitted, reviewed and modified.
2. The applicant shall submit plans for a demolition permit to the City of The Dalles and then Wasco County Building Codes.
3. The applicant shall submit plans for a building permit to City of The Dalles and then Wasco County Building Codes.
4. The applicant shall submit a Physical Constraints Permit to be reviewed and approved by the City Engineer for all cut/fill, grading, and groundwork required for the construction of the new structure.
5. If historical artifacts over 75 years old are found on the site in relation to the proposed project, resulting from land disturbance, excavation, or grading

activities, all applicable state laws and regulations shall be followed in accordance with the guidance of the State Archeologist.

6. The applicant is required to notify the Community Development Department of any alteration of approved plans.

III. APPEALS, COMPLIANCE AND PENALTIES:

- A. Any party of record may appeal a decision of the Historic Landmarks Commission to the City Council for review. Appeals must be made in accordance to Article 11.12.090 of The Dalles Municipal Code, Chapter 11.12 Historic Resources, and must be filed with the City Clerk within ten (10) days of the date of mailing of this Order.
- B. Failure to exercise this approval within the time line set either by Order or by The Dalles Municipal Code will invalidate this permit.

ADOPTED THIS 22ND DAY OF JANUARY, 2025.

Robert McNary, Chair
Historic Landmarks Commission

I, Joshua Chandler, Director, Community Development Department of the City of the Dalles, hereby certify that the foregoing Order was adopted at the meeting of the City Historic Landmarks Commission, held on January 22, 2025.

AYES: _____

NAYS: _____

ABSENT: _____

ABSTAIN: _____

ATTEST: _____
Joshua Chandler, Director
Community Development Department, City of The Dalles



HISTORIC LANDMARKS RESOLUTION NO. 204-25

Adopting The Dalles Historic Landmarks Commission Application #218-24, Tom Giamei.

This application is for a Historic Landmarks Commission hearing to gain approval to replace four windows on the northeast wall and one door facing Court Street. The property is located at 201 E. 2nd Street and further described as 1N 13E 3 BD tax lot 3900. The Schanno Building, commonly known as the American Legion Building, is an Italianate style structure constructed c. 1892, and a secondary contributing resource located in the National Commercial Historic District. Property is zoned CBC – Central Business Commercial, with a CBC-1 and CBC-2 Overlay.

RECITALS:

- A. The Historic Landmarks Commission of the City of The Dalles has, on January 22, 2025 conducted a public hearing to consider the above request.
- B. A Staff Report was presented, stating findings of fact and conclusions of law.
- C. Staff Report 218-24 and the minutes of the January 22, 2025 hearing, upon approval, provide the basis for this resolution and are herein attached by reference.

II. **RESOLUTION:** Now, therefore, be it FOUND, DETERMINED, and ORDERED by the Historic Landmarks Commission of the City of The Dalles as follows:

- A. In all respects as set forth in Recitals, Part “I” of this resolution.
- B. Historic Landmarks Review 218-24, **Tom Giamei**, is *approved* with the following conditions:

Conditions of Approval:

1. Work shall be completed in substantial conformance to the pictures and proposals as submitted, reviewed and/or modified.
2. The replacement door on Court Street shall compliment the building and meet applicable design standards. If building code requirements are contrary to the design standards, the applicant will need to work with both the City and Building Codes to ensure that the materials are complimentary to the historic building and the design guidelines.
3. The applicant shall submit plans for a building permit to City of The Dalles and then Wasco County Building Codes.
4. If historical artifacts over 75 years old are found on the site in relation to the proposed project, resulting from land disturbance, excavation, or grading activities, all applicable state laws and regulations shall be followed in accordance with the guidance of the State Archeologist.

- 5. The applicant is required to notify the Community Development Department of any alteration of approved plans.

III. APPEALS, COMPLIANCE AND PENALTIES:

- A. Any party of record may appeal a decision of the Historic Landmarks Commission to the City Council for review. Appeals must be made in accordance to Article 11.12.090 of The Dalles Municipal Code, Chapter 11.12 Historic Resources, and must be filed with the City Clerk within ten (10) days of the date of mailing of this Order.
- B. Failure to exercise this approval within the time line set either by Order or by The Dalles Municipal Code will invalidate this permit.

ADOPTED THIS 22ND DAY OF JANUARY, 2025.

Robert McNary, Chair
Historic Landmarks Commission

I, Joshua Chandler, Director, Community Development Department of the City of the Dalles, hereby certify that the foregoing Order was adopted at the meeting of the City Historic Landmarks Commission, held on January 22, 2025.

AYES: _____

NAYS: _____

ABSENT: _____

ABSTAIN: _____

ATTEST: _____

Joshua Chandler, Director
Community Development Department, City of The Dalles

City of The Dalles
Historic Landmarks Commission
2025 Goals

Short-Term Goals (1-2 years):

1. Update Historic Ordinance and Design Standards to be clear and objective.
2. Encourage the addition of a student representative on the Historic Landmarks Commission.
3. Apply for a grant to create a Preservation Plan for The Dalles.
4. Develop a concept design for new historic building plaques and promote their fabrication and installation throughout the community.
5. Support the creation of tours of historic properties, including the Pioneer Cemetery.
6. Encourage the restoration and preservation of the Pioneer Cemetery and establish an inventory available on the City of The Dalles website.
7. Encourage the restoration of the upstairs windows of the Waldron-Gitchell Building.
8. Update historic inventories and encourage new nominations to local and national registries, including the addition of Amotan Field.
9. Research the historical significance of the “Rock House” and former railroad structures along East Second Street near Brewery Grade Overpass.

Continuous Goals:

10. Provide a historic restoration workshop for local homeowners and contractors.
11. Provide landscaping, informational signage, and maintenance of the Pioneer Cemetery.
12. Encourage preservation and re-use of the Waldron-Gitchell Building.
13. Collaborate with Main Street and The Dalles Art Center on further downtown restoration project goals.
14. Make historic preservation educational and funding resources available online to assist restorers with assessment and other historic preservation needs.
15. Provide annual recognition of historic restorations at the annual goal setting meetings.
16. Provide onsite acknowledgements for notable restorations.
17. Encourage historic restoration for downtown by providing historic background research.
18. Encourage the collection and preservation of local history, including irreplaceable oral and written histories.

19. Support Historic Preservation Month, local historic preservation, and educational workshops.
20. Assist with historic plaque costs and availability.
21. Keep the Historic Walking Tour current in all formats.
22. Increase communication on all Urban Renewal and Main Street projects, vision and goals.
23. Provide optional historic and procedural commissioner trainings.
24. Support the Fort Dalles/Anderson Homestead Museum and the Vehicle Storage Display Building.
25. Support and advocate for the preservation and continued use of The Dalles High School and Colonel Wright Elementary School.
26. Encourage continued preservation and compatible infill of Historic Chinatown.
27. Encourage preservation and continued use of Rock Fort by following the adopted Preservation and Maintenance Plan.
28. Continue to support, advocate, and preserve historic properties throughout the community.

City of The Dalles
Historic Landmarks Commission
2025 Goals

Short-Term Goals (1-2 years):

- Update Historic Ordinance and Design Standards to be clear and objective.
- ~~• Provide a historic restoration workshop for local homeowners and contractors.~~
- Encourage the addition of a student representative on the Historic Landmarks Commission.
- Apply for a grant to create a Preservation Plan for The Dalles.
- ~~Develop a concept design for new historic building plaques and promote their fabrication and installation throughout the community.~~ Create a concept design for historic building plaques.
- ~~Encourage the fabrication and installation of historic plaques throughout the community, including Amotan Field.~~
- Support the creation of tours of historic properties, including and the Pioneer Cemetery.
- ~~• Provide landscaping, informational signage, and maintenance of the Pioneer Cemetery.~~
- Encourage the restoration and preservation of the Pioneer Cemetery and establish an inventory available on the City of The Dalles website.
- Encourage the restoration of the upstairs windows of the Waldron-Gitchell Building.
- Update historic inventories and encourage new nominations to local and national registries, including the addition of Amotan Field.
- Research the historical significance of the “Rock House” and former railroad structures along East Second Street near Brewery Grade Overpass.
- Support the installation of the light capsule art project at the Waldron-Gitchell Building.

Commented [JC1]: Goals combined.

Formatted: Indent: Left: 0.5"

Commented [JC2]: Moved from Continuous to Short-Term Goals

Commented [JC3]: New goal added

Commented [JC4]: Work completed in 2024

Continuous Goals:

- ~~• Provide a historic restoration workshop for local homeowners and contractors.~~
- ~~•~~
- ~~• Provide landscaping, informational signage, and maintenance of the Pioneer Cemetery.~~
- ~~•~~

Commented [JC5]: Moved from Short-Term to Continuous Goals

Commented [JC6]: Moved from Short-Term to Continuous Goals

- Encourage preservation and re-use of the Waldron-Gitchell Building.
- Collaborate with Main Street and The Dalles Art Center on further downtown restoration project goals.
- Make historic preservation educational and funding resources available online to assist restorers with assessment and other historic preservation needs.
- Provide annual recognition of historic restorations at the annual goal setting meetings.
- Provide onsite acknowledgements for notable restorations.
- Encourage historic restoration for downtown by providing historic background research.
- Encourage the collection and preservation of local history, including irreplaceable oral and written histories.

~~• Update historic inventories and encourage new nominations to local and national registries.~~

~~• Maintain Certified Local Government status.~~

- Support Historic Preservation Month, local historic preservation, and educational workshops.
- Assist with historic plaque costs and availability.
- Keep the Historic Walking Tour current in all formats.
- Increase communication on all Urban Renewal and Main Street projects, vision and goals.
- Provide optional historic and procedural commissioner trainings.
- Support the Fort Dalles/Anderson Homestead Museum and the Vehicle Storage Display Building.
- Support and advocate for the preservation and continued use of The Dalles High School and Colonel Wright Elementary School.
- Encourage continued preservation and compatible infill of Historic Chinatown.
- Encourage preservation and continued use of Rock Fort by following the adopted Preservation and Maintenance Plan.
- Continue to support, advocate, and preserve historic properties throughout the community.

Commented [JC7]: Removed from list. It is the City's continued commitment to maintain CLG status and the Board felt this was no longer needed as a specific goal.