



TOWN BOARD REGULAR MEETING
November 14, 2016 - 7:00 P.M.
Town Board Chambers
301 Walnut Street, Windsor, CO 80550

The Town of Windsor will make reasonable accommodations for access to Town services, programs, and activities and will make special communication arrangements for persons with disabilities. Please call (970) 674-2400 by noon on the Thursday prior to the meeting to make arrangements.

AGENDA

A. CALL TO ORDER

1. Roll Call
2. Pledge of Allegiance
3. Review of Agenda by the Board and Addition of Items of New Business to the Agenda for Consideration by the Board
4. Proclamation National Adoption Day 2016
5. Board Liaison Reports
 - Mayor Pro Tem Baker – Parks, Recreation & Culture Advisory Board; North Front Range/MPO alternate
 - Town Board Member Morgan – Water & Sewer Board; Clearview Library Board
 - Town Board Member Bennett – Planning Commission; Windsor Housing Authority
 - Town Board Member Rennemeyer – Historic Preservation Commission; Great Western Trail Authority
 - Town Board Member Boudreau – Chamber of Commerce; Planning Commission alternate
 - Town Board Member Adams – Tree Board; Poudre River Trail Corridor Board
 - Mayor Melendez – Downtown Development Authority; North Front Range/MPO
6. Public Invited to be Heard

Individuals wishing to participate in Public Invited to be Heard (non-agenda item) are requested to sign up on the form provided in the foyer of the Town Board Chambers. When you are recognized, step to the podium, state your name and address then speak to the Town Board.

Individuals wishing to speak during the Public Invited to be Heard or during Public Hearing proceedings are encouraged to be prepared and individuals will be limited to three (3) minutes. Written comments are welcome and should be given to the Deputy Town Clerk prior to the start of the meeting.

B. CONSENT CALENDAR

1. Minutes of the October 24, 2016 – K. Eucker
2. Resolution No. 2016-74 - A Resolution Approving and Adopting the Second Amendment to First Amended Intergovernmental Agreement between the Town of Windsor and City of Fort Collins with Respect to the Development of the Interstate 25/State Highway 392 Interchange – I. McCargar
3. Report of Bills – D. Moyer

C. BOARD ACTION

1. Resolution No. 2016-75 - A Resolution Approving an Amendment to Water Lease between the Town of Windsor, Colorado, and Front Range Energy, LLC
 - Legislative action
 - Staff presentation: Ian McCargar, Town Attorney

2. Resolution No. 2016-76 - A Resolution Approving an Agreement for Certain Economic Inducements and Development Incentives Between the Town of Windsor, Colorado, and Windsor Hotel Partners, LLC, with Respect to the Development of Property for Commercial Purposes Within the Town of Windsor
 - Legislative action
 - Staff presentation: Stacy Johnson, Director of Economic Development

3. Introduction and Update on the Master Planning Process for The Ranch
 - Presenter: Bob Herrfeldt, Director

D. COMMUNICATIONS

1. Communications from the Town Attorney
2. Communications from Town Staff
3. Communications from the Town Manager
4. Communications from Town Board Members

E. ADJOURN



PROCLAMATION

NATIONAL ADOPTION DAY 2016

WHEREAS, the Town of Windsor, Colorado recognizes the importance of giving children permanent, safe and loving families through adoption; and

WHEREAS, more than 100,000 children in the U.S. foster care system are waiting to be adopted; and

WHEREAS, more than 280 children in Colorado are waiting for permanent families; more than 30 children in the Windsor/Greeley/Weld County area are waiting for permanent families; and

WHEREAS, to celebrate adoptive families and help raise awareness for the need of permanent, nurturing families, the Weld County Department of Human Services and the 19th Judicial District will hold a special celebration on November 18, 2016 to finalize the adoptions of local children and join other organizations to celebrate all adoptions; and

WHEREAS, this effort, along with similar celebrations in all 50 states, the District of Columbia, Guam and Puerto Rico will offer children the chance to live with stable and loving families and encourage other dedicated individuals to make a powerful difference in the lives of a child through adoption;

NOW, THEREFORE, I, Mayor Kristie Melendez of Windsor, Colorado, by virtue of the authority vested in me, do hereby proclaim November 18, 2016 as Weld County Adoption Day, and November 19, 2016 as National Adoption Day in Windsor, and in so doing, urge all citizens to join in a national effort to raise awareness about the importance of adoption.

Dated this 14th day of November, 2016

Kristie Melendez
Mayor of Windsor, Colorado



TOWN BOARD REGULAR MEETING
October 24, 2016 - 7:00 P.M.
Town Board Chambers
301 Walnut Street, Windsor, CO 80550

The Town of Windsor will make reasonable accommodations for access to Town services, programs, and activities and will make special communication arrangements for persons with disabilities. Please call (970) 674-2400 by noon on the Thursday prior to the meeting to make arrangements.

MINUTES

A. CALL TO ORDER

Mayor Melendez called the meeting to order at 7:08 p.m.

- | | | |
|--------------|------------------------|---|
| 1. Roll Call | Mayor
Mayor Pro Tem | Kristie Melendez
Myles Baker
Christian Morgan
Ken Bennett
Paul Rennemeyer
Brenden Boudreau
Ivan Adams |
|--------------|------------------------|---|

Also Present:

- | | |
|---|-----------------|
| Town Manager | Kelly Arnold |
| Town Prosecutor | Kim Emil |
| Town Clerk/ Assistant to Town Manager | Patti Garcia |
| Communications/Assistant to Town Manager | Kelly Unger |
| Chief of Police | Rick Klimek |
| Communications Manager | Katie Van Meter |
| Director of Parks, Recreation and Culture | Eric Lucas |
| Director of Finance | Dean Moyer |
| Director of Economic Development | Stacy Johnson |
| Director of Planning | Scott Ballstadt |
| Senior Planner | Josh Olhava |
| Deputy Town Clerk | Krystal Eucker |

2. Pledge of Allegiance
Mayor Pro Tem Baker led the Pledge of Allegiance.
3. Review of Agenda by the Board and Addition of Items of New Business to the Agenda for Consideration by the Board
Town Board Member Adams moved to approve the agenda as presented; Town Board Member Morgan seconded the motion. Roll call on the vote resulted as follows: Yeas –Baker, Morgan, Bennett, Rennemeyer, Boudreau, Adams, Melendez; Nays- None; Motion passed.
4. Mayor Melendez read the National Community Planning Month proclamation.
5. Board Liaison Reports
 - Mayor Pro Tem Baker – Parks, Recreation & Culture Advisory Board; North Front Range/MPO alternate
Mayor Pro Tem Baker had no report.

- Town Board Member Morgan – Water & Sewer Board; Clearview Library Board
Town Board Member Morgan reported the Library Board will meet on October 27, 2016. Mr. Morgan reported Mr. Rennemeyer attended Water and Sewer Board and will provide a report.
- Town Board Member Bennett – Planning Commission; Windsor Housing Authority
Town Board Member Bennett reported the items addressed at the Planning Commission meeting are on tonight's agenda.
Mr. Bennett reported the Windsor Housing Authority (WHA) is working on the 2017 budget. The WHA is looking for land to purchase to build additional housing for seniors and also looking at capital improvements of the existing Century III properties which could be cabinets, adding dryers to the units, floor leveling and/or expanding the clubhouse. The current cabinets were constructed in 1968 and 1972 and they have been informed that those cabinets may have better quality wood than purchasing new cabinets so they may look into refurbishing. Some of the residents are from a generation that did not use dryers and said they would be happy to not have dryers as they like drying their cloths outside.
- Town Board Member Rennemeyer – Historic Preservation Commission; Great Western Trail Authority.
Town Board Member Rennemeyer reported the Water and Sewer Board reviewed the 2017 budget.
Mr. Rennemeyer stated the Historic Preservation Commission has not meet but the research project by CSU is ongoing.
Mr. Rennemeyer had no update for the Great Western Trail Authority.
- Town Board Member Boudreau – Chamber of Commerce; Planning Commission alternate
Town Board Member Boudreau reported the Chamber of Commerce met on October 12, 2016 and completed an event wrap up of the Meet the Leaders event, completed final details of the Annual Chamber Dinner event and discussed the two upcoming vacancies.
- Town Board Member Adams – Tree Board; Poudre River Trail Corridor Board
Town Board Member Adams reported the Tree Board will meet on October 25, 2016. Mr. Adams reported the Poudre River Trail Corridor Board may be postponing their meeting as the retreat has been rescheduled to November 30, 2016.
- Mayor Melendez – Downtown Development Authority; North Front Range/MPO
Mayor Melendez reported the Downtown Development Authority met on October 12, 2016 and has been working on the Mill project coordination as well as the back lots to correct some easements. The 2017 budget was approved and it was also approved to move to five mills. Some of the upcoming events include the Downtown Halloween Trick-or-Treat, Shop Local for business Saturday and Windsor Wonderland.

6. Public Invited to be Heard

Mayor Melendez opened the meeting up for public comment to which there was none. Ms. Melendez recognized two boy scouts in the audience earing their citizenship badges.

B. CONSENT CALENDAR

1. Minutes of the October 10, 2016 – K. Eucker

2. Resolution No. 2016-71 – A Resolution Approving the Accessioning of Items to the Town of Windsor Museum Collection – E. Lucas
3. Resolution No. 2016-72 – A Resolution Appointing Directors To The Boards Of Directors Of The Raindance Metropolitan District Nos. 1-4 – I. McCargar
Mayor Pro Tem Baker moved to approve the consent calendar as presented; Town Board Member Bennett seconded the motion. Roll call on the vote resulted as follows: Yeas –Baker, Morgan, Bennett, Rennemeyer, Boudreau, Adams, Melendez; Nays- None; Motion passed.

C. BOARD ACTION

1. Ordinance No. 2016-1526 Repealing and Amending Portions of Chapter 17 Article XIII of the Municipal Code regarding Enhanced Design Standards for development within the I-25/SH 392 Interchange Corridor Activity Center Area (CAC)
Super-majority vote required for adoption on second reading
 - Second reading
 - Legislative action
 - Staff presentation: Scott Ballstadt, Director of Planning

Per Mr. Ballstadt, the enhanced design standards would supplement the design standards that are currently in the municipal code and would apply to all new development within the I-25/SH 392 Interchange Corridor Activity Center (CAC) in Windsor. The design standards were the subject of multiple public meetings in late 2015 and early 2016.

The Fort Collins City Council has adopted similar design standards and passed Fort Collins Resolution 2016-070 recommending to the Windsor Town Board approval of the proposed design standards. The standards would enhance requirements for site design, landscaping, parking, building design and orientation, compatibility and lighting.

Staff recommends approval of the Ordinance No. 2016-1526 on second reading.

Ms. Melendez inquired if the documents from the public invited to be heard have been included in the records.

Per Mr. Ballstadt; I believe so which also includes the emails from the first reading.

Town Board Member Morgan moved to approve Ordinance No. 2016-1526 Repealing and Amending Portions of Chapter 17 Article XIII of the Municipal Code regarding Enhanced Design Standards for development within the I-25/SH 392 Interchange Corridor Activity Center Area (CAC); Town Board Member Rennemeyer seconded the motion. Roll call on the vote resulted as follows: Yeas –Baker, Morgan, Bennett, Rennemeyer, Boudreau, Adams, Melendez; Nays- None; Motion passed.

2. Resolution No. 2016-73 – A Resolution of the Windsor Town Board Supporting the Passage of Measures Referred to the Voters by the Weld RE-4 School District Board for Consideration on November 8, 2016
 - Legislative action

- Presentation: Kristie Melendez, Mayor

Mr. Boudreau commented that he is a renter in Windsor and would not be directly paying the tax if passed therefor he feels it is not right to ask residents to vote for a tax increase that he will not be directly paying for.

Town Board Member Adams moved to approve Resolution No. 2016-73, Town Board Member Bennett seconded the motion. Roll call on the vote resulted as follows: Yeas –Baker, Morgan, Bennett, Rennemeyer, Adams, Melendez; Nays- Boudreau; Motion passed.

Weld RE-4 School Board thanked Windsor for their support.

3. Resolution No. 2016-74 - A Resolution Appointing the Presiding Judge and Associate Judge for the Town of Windsor Municipal Court, and Confirming the Term of Office for Each
 - Legislative action
 - Staff presentation: Kim Emil, Assistant Town Attorney

Per Ms. Emil, in anticipation of the retirement of Hon. Michael E. Manning, the Home Rule Charter requires the appointment of a new Presiding Judge. Depending on who the selection was for the new Presiding Judge, a new Associate Judge would need to be selected as well. The interviews have taken place and the Town Board selected Teresa Ablao who is currently Windsor's Associate Judge to serve as the Municipal Judge and Michelle R. Kline was selected to serve as the Associate Judge in the event that Ms. Ablao cannot be present. The swearing-in ceremony is currently scheduled for Monday, December 12, 2016.

The Charter requires a majority vote for the appointment of judicial officers.

Mr. Rennemeyer inquired if the individuals need to accept the decision of the Board.

Ms. Emil stated that Mr. McCargar has contacted both individuals and believe they are willing to accept.

Ms. Melendez commented that she will be voting no on this resolution.

Town Board Member Bennett moved to approve Resolution No. 2016-74, Town Board Member Boudreau seconded the motion. Roll call on the vote resulted as follows: Yeas –Baker, Morgan, Bennett, Rennemeyer, Boudreau, Adams; Nays- Melendez; Motion passed.

4. Site Plan Presentation – River Valley Crossing Subdivision, Lot 5 – Christian Brothers Automotive – Stephen Greenlee, owner/ Todd Rand, Baseline Engineering Corporation and Jonathan Wakefield, Christian Brothers Automotive Corporation, applicant's representatives
 - Staff presentation: Josh Olhava, Senior Planner

Per Mr. Olhava, the applicant, represented by Mr. Todd Rand and Mr. Jonathan Wakefield, is proposing a new site development in the River Valley Crossing Subdivision. The site is zoned General Commercial (GC), located within the Commercial Corridor Plan area along Main

Street/SH 392 and surrounded by other commercially zoned property on all sides. The application, as submitted, is in conformance with the Commercial Corridor Plan.

Site characteristics include:

- a new 4,960-square foot automotive repair store;
- 29 dedicated, off-street parking spaces, including two accessible parking spaces; and
- over 30% of the site to be landscaped.

Building and structural details include:

- the use of brick as the primary façade element and limestone veneer as a wainscoting;
- decorative tile and architectural precast keystone integrated into the brick facade; and
- 9 overhead garage door bays facing east towards the parking lot.

The application is consistent with various goals of the 2016 Comprehensive Plan as well as the Vision 2025 document.

Mr. Baker inquired about the north facing elevation.

Mr. Olhava stated the north facing elevation is the office space and the western elevation is adjacent to a vacant lot which will include landscaping that will break up the brick façade.

Mr. Baker inquired if there is any parking along the west side.

Mr. Olhava stated there is no parking on the west side. The applicant can speak more to the design of the building.

Mr. Morgan inquired as to what the roofing materials may be.

Mr. Olhava stated it will be green colored asphalt shingles.

Mr. Rennemeyer inquired as to why there is no stone on the west elevation.

Mr. Olhava stated based on the corridor plan it is not required along that section.

Mr. Adams inquired as to where the site is.

Mr. Olhava stated it is on the west side of Safeway and south of Highway 392.

Mr. Arnold inquired as to who maintains the site landscaping.

Mr. Olhava stated the applicant will be responsible for the landscaping unless there is an agreement in place for the maintenance.

Applicant's representative Jonathan Wakefield commented that business is a light automotive repair facility. It is anticipated that when the adjacent property is sold, they will place their building right next to our building in turn placing more focus on the parts of the building that are highly visible. The franchisees live in the community and will be working at the business.

Mr. Baker inquired if vehicles being stored overnight.

Mr. Wakefield stated the nine bays allow for the preponderance of vehicles to be stored there. There is a night drop which would be parked outside and 90% of the vehicles arrive at the store on their own so the store also does not have a town truck.

5. Site Plan Presentation – Cornerstone Subdivision 1st Filing, Lot 1, Block 1 – Tolmar Windsor Campus – Charles Mays, Tolmar Inc., applicant/Jon Sweet, TST Inc., applicant’s representative
- Staff presentation: Carlin Barkeen, Chief Planner

Per Mr. Ballstadt, the current presentation is intended for the Town Board’s information. The project site is part of a 13.35-acre lot zoned I-L (Limited Industrial).

The surrounding zoning is primarily commercial to the south and east with more industrial to the east as well as residential to the north and west. The existing site was previously a box company built in the 1980’s and over the past several years Tolmar has been renovating the interior of the space.

The redevelopment of the site, including adjacent right-of-way, includes:

Drainage improvements;

- Right-of-way improvements, including driveway/access points on Cornerstone Drive, adjacent sidewalks and accessible ramps, and landscaping;
- On-site parking lot and landscaping upgrades; and
- Screening of mechanical equipment.

The application is consistent with various goals of the 2016 Comprehensive Plan as well as the Vision 2025 document.

The applicant’s representative Mr. Charles Mays provided a background of Tolmar stating they are a pharmaceutical company and gave an overview of various products that they offer, their employee base and facility locations, the expansion at Eastman Park and the inclusion of clean rooms and laboratories in the facility. Mr. Mays stated they are not just transferring jobs to the facility but they are expanding operations in Windsor.

Mr. Morgan inquired as to the philosophy on security of the production facility

Mr. Mays stated they are very driven by standard operating procedures; doors may not be propped open, badges are required for all employees and contractors (contractors are certified), employees are at the site at night and there are also on-call employees.

Mr. Morgan inquired if there have been meetings with police and fire regarding the facility.

Mr. Mays stated there are three safety employees that are continuously meeting with the fire chief.

Mr. Adams inquired if the north boundary of the site goes right up to homes.

Mr. Mays stated there is an open field that extends to the back fence of those homes.

Mr. Adams inquired as to who maintains the open field.

Mr. Mays stated Tolmar is maintaining that space with a contracted landscape crew.

Ms. Melendez inquired if the site plan is primarily landscaping or is there work being done on the building as well.

Mr. Mays stated at this time it is mainly grading, striping, resurfacing the parking lot, landscaping, water flow retention areas and also a fence on the east side of the building.

Mr. Arnold inquired if the land to the north is anticipated for future development.

Mr. Mays stated at this time it is uncertain.

Mr. Arnold inquired as to the traffic flow for employees and the round-a-bout.

Mr. Mays stated the round-a-bout is functioning well for the employees.

6. Economic Development Report

- Staff presentation: Stacy Johnson, Director of Economic Development

Ms. Johnson gave an overview of the Economic Development Report that was provided to the Board. Eagle Crossing, one of the largest incentives to date is almost completely paid back in two years versus the estimated three years. There has been an increase in inquiries for larger spaces (100,000-300,000 square feet) which Windsor does not qualify for. The number of leads and prospect visits was the largest in September than it has been in the months that have been tracked.

7. Financial Report for September 2016

- Staff presentation: Dean Moyer, Director of Finance

Mr. Moyer gave an overview of the September 2016 Financial Report that was included in the packet material.

- Base sales tax collections as well as the CRC Expansion tax have exceeded the monthly requirement in September 2016.
- Single family building permits total 545 through September 2016; up 239 permits from September of 2015.
- 37 business licenses were issued of which 23 were sales tax vendors.
- Construction use tax through September is at 133.3% of the annual budget at \$2,352,257.
- Benchmark for revenue collections at this point in the year is 75% which has been exceeded.
- A sales tax refund was issued in the amount of \$85,852 as the transaction did not happen in city limits in September of 2015.
- Expenditure benchmark for this time of year is 75% and it is currently at 72%.

Mr. Rennemeyer inquired as to the number of memberships at the CRC.

Mr. Lucas stated the membership total was 1690 and the goal is to increase to 3,000 memberships through the end of the year and 4,000 by the end of 2017. An average of 1,000 individuals come through the building per day.

Mr. Arnold stated a final report will be presented to the Town Board by the end of the year.

D. COMMUNICATIONS

1. Communications from the Town Attorney

None

2. Communications from Town Staff

Mr. Ballstadt informed the Board of Mr. Olhava's NoCo 40 Under Forty nomination.

Mr. Lucas invited the Town Board to the pickleball court ribbon cutting on November 1, 2016.

Ms. Melendez inquired if the nets are up year round.

Mr. Lucas stated the nets may be taken down when winter really sets in so the snow does not put tension on the nets but other than that they will stay up.

Mr. Klimek commented the national drug take back collected 212 pounds of prescription drugs.

Ms. VanMeter stated the Community Halloween Party will be held on October 31, 2016 at the CRC from 6:00 p.m. – 8:00 p.m.

4. Communications from the Town Manager

Mr. Arnold inquired if the Board had any questions regarding the 2017 budget.

Mr. Baker inquired if there was any direction needed on the credit card fee issue.

Mr. Arnold stated there is not.

Mr. Arnold stated next Monday is the 5th Monday and there will be no meeting. There is a work session scheduled on November 2, 2016 at 6:00 p.m. with the Town of Severance and the Windsor Planning Commission. The Planning Commission will move into their regular meeting following the work session.

5. Communications from Town Board Members

Ms. Melendez reminded the Board Member of the Windsor-Severance Historical Society event on October 28, 2016.

Mr. Rennemeyer inquired if there was any new developments that could be shared on the Mill project.

Mr. Arnold stated there is not.

E. ADJOURN

Town Board Member Boudreau moved to adjourn; Town Board Member Rennemeyer seconded the motion. Roll call on the vote resulted as follows: Yeas –Baker, Morgan, Bennett, Rennemeyer, Boudreau, Adams, Melendez; Nays- None; Motion passed.

The meeting was adjourned at 8:22 p.m.

Krystal Eucker, Deputy Town Clerk



MEMORANDUM

Date: November 14, 2016
To: Mayor and Town Board
Via: Regular meeting materials, November 14, 2016
From: Ian D. McCargar, Town Attorney
Re: Amendment to Fort Collins IGA (I-25 & 392)
Item #: B.2.

Background / Discussion:

The existing Intergovernmental Agreement with Fort Collins requires a written agreement to approve any modification of development standards in the I-25/State Highway 392 Corridor Activity Center ("CAC").

Even though each municipality has taken official action to adopt the CAC Enhanced Design Standards with the informal consent of the other, the City Attorney and I are recommending that a formal amendment to the IGA be approved and executed by our clients.

The attached Resolution Approving and Adopting the Second Amendment to First Amended Intergovernmental Agreement between the Town of Windsor and City of Fort Collins with Respect to the Development of the Interstate 25/State Highway 392 Interchange represents official action in support of the proposed Amendment.

The attached Second Amendment to First Amended Intergovernmental Agreement between the Town of Windsor and City of Fort Collins with Respect to the Development of the Interstate 25/State Highway 392 Interchange is the actual formal amendment for execution by the Town Manager.

Financial Impact: None

Relationship to Strategic Plan: Prosperous local economy

Recommendation: Approve attached Resolution Approving and Adopting the Second Amendment to First Amended Intergovernmental Agreement between the Town of Windsor and City of Fort Collins with Respect to the Development of the Interstate 25/State Highway 392 Interchange. Simple majority required.

Attachments:

Resolution Approving and Adopting the Second Amendment to First Amended Intergovernmental Agreement between the Town of Windsor and City of Fort Collins with Respect to the Development of the Interstate 25/State Highway 392 Interchange

Second Amendment to First Amended Intergovernmental Agreement between the Town of Windsor and City of Fort Collins with Respect to the Development of the Interstate 25/State Highway 392 Interchange

TOWN OF WINDSOR

RESOLUTION NO. 2016-74

A RESOLUTION APPROVING AND ADOPTING THE SECOND AMENDMENT TO FIRST AMENDED INTERGOVERNMENTAL AGREEMENT BETWEEN THE TOWN OF WINDSOR AND CITY OF FORT COLLINS WITH RESPECT TO THE DEVELOPMENT OF THE INTERSTATE 25/STATE HIGHWAY 392 INTERCHANGE

WHEREAS, the Town of Windsor (“Town”) is a Colorado home rule municipality with all powers and authority vested by Colorado law; and

WHEREAS, the Town and the City of Fort Collins (“City”) entered into a Comprehensive Development Plan via an Intergovernmental Agreement Pertaining to the Development of the Interstate I-25/State Highway 392 Interchange (“IGA”), beginning on January 3, 2011, subsequently amended in 2013 (“First Amended Agreement”); and

WHEREAS, these agreements incorporated “CAC Design Standards” setting forth the anticipated design standards for the I-25/Highway 392 Corridor Activity Center (“CAC”); and

WHEREAS, both the Town and the City agree that the original standards should be modified and enhanced, now referred to as the “CAC Enhanced Design Standards” which shall apply to all development within the CAC; and

WHEREAS, Title 29, Article 1 of the Colorado Revised Statutes encourages and permits local governments to cooperate in the provision of any function, service, or facility lawfully authorized to each of the cooperating entities, including the sharing of costs, the imposition of taxes, or the incurring of debt, so long as such cooperation is authorized by each party thereto with the approval of its governing body; and

WHEREAS, § 29-20-105 encourages local governments to cooperate or contract with others for the purposes of planning or regulating the development of land, including, but not limited to, the joint exercise of planning, zoning, subdivision, building and related regulations, including the joint adoption of comprehensive development plans for areas within their jurisdictions; and

WHEREAS, both the Town and the City have adopted their versions of the CAC Enhanced Design Standards, and now wish to amend the IGA to memorialize their consent and agreement to the adoption of the CAC Enhanced Design Standards and amend the First Amended Agreement to incorporate the City and Town versions of the CAC Enhanced Design Standards.

NOW, THEREFORE, be it resolved by the Town Board for the Town of Windsor, Colorado, as follows:

1. The attached Second Amended Intergovernmental Agreement between the Town of Windsor and City of Fort Collins with Respect to the Development of the Interstate 25/State Highway 392 Interchange, is hereby approved and adopted.
2. The Town Manager is hereby authorized to execute the attached Intergovernmental Agreement on behalf of the Town.
3. The Town Attorney is authorized to make such modifications to the form of the attached Intergovernmental Agreement as may be necessary to carry out the intent of this Resolution.

Upon motion duly made, seconded and carried, the foregoing Resolution was adopted this November 14, 2016.

TOWN OF WINDSOR, COLORADO

By: _____
Kristie Melendez, Mayor

ATTEST:

Patti Garcia, Town Clerk

**SECOND AMENDMENT TO FIRST AMENDED INTERGOVERNMENTAL
AGREEMENT PERTAINING TO THE DEVELOPMENT OF THE INTERSTATE
25/STATE HIGHWAY 392 INTERCHANGE
(Enhanced Design Standards)**

THIS SECOND AMENDMENT TO FIRST AMENDED INTERGOVERNMENTAL AGREEMENT PERTAINING TO THE DEVELOPMENT OF THE INTERSTATE 25/STATE HIGHWAY 392 INTERCHANGE (“Second Amendment”) is entered into this _____ day of November, 2016, by and between the City of Fort Collins, Colorado, a Colorado home rule municipality (the “City”), and the Town of Windsor, Colorado, a Colorado home rule municipality (the “Town”), collectively referred to herein as the “Parties”.

RECITALS

WHEREAS, on January 3, 2011, the City and the Town entered into that certain Intergovernmental Agreement Pertaining To The Development Of The Interstate I25/State Highway 392 Interchange (“Agreement”); and

WHEREAS, on November 27, 2012, the City and the Town entered into the First Amended Intergovernmental Agreement Pertaining to the Development of the Interstate 25/State Highway 392 Interchange, which superseded the Agreement, as amended by that certain Intergovernmental Agreement Amending Certain Provisions of the First Amended Intergovernmental Agreement Pertaining to the Development of the Interstate 25/State Highway 392 Interchange dated May 9, 2013 (collectively, the “First Amended Agreement”); and

WHEREAS, both the Agreement and First Amended Agreement incorporated development standards for the I-25/Highway 392 Corridor Activity Center, referred to therein as the “CAC Design Standards”; and

WHEREAS, since the approval of the Agreement and First Amended Agreement, the parties have in concert adopted modifications to the CAC Design Standards, which are now referred to as the “CAC Enhanced Design Standards”; and

WHEREAS, the City adopted its version of the CAC Enhanced Design Standards by adoption of Ordinance No. 107-2016; and

WHEREAS, the Town adopted its version of the CAC Enhanced Design Standards by adoption of Ordinance No. 2016-1526; and

WHEREAS, the parties agree that their respective ordinances have established consistent and substantially-identical standards for development within the I-25/Highway 392 Corridor Activity Center; and

WHEREAS, by entering into this Second Amendment, the City and the Town wish to memorialize their consent and agreement to adoption of the CAC Enhanced Design Standards

and amendment of the First Amended Agreement to incorporate the City and Town versions of the CAC Enhanced Design Standards.

NOW, THEREFORE, the parties agree as follows:

1. The foregoing Recitals are true, correct and incorporated herein.
2. The adoption of the CAC Enhanced Design Standards as set forth in Ordinance No. 107-2016 by the City was and is approved by the Town.
3. The adoption of the CAC Enhanced Design Standards as set forth in Ordinance No. 2016-1526 by the Town was and is approved by the City.
4. The CAC Enhanced Design Standards shall apply to all development within the I-25/Highway 392 Corridor Activity Center, and are hereby incorporated into the Comprehensive Development Plan created under the Agreement and the First Amended Agreement. All references to the "CAC Design Standards" set forth in the First Amended Agreement, including but not limited to the provisions of Section 3.2 of such Agreement, are hereby amended to include the CAC Enhanced Design Standards adopted by each party as set forth above.
5. Except as set forth herein, the First Amended Agreement shall remain in full force and effect.

WHEREFORE, the duly-appointed representatives of the parties have executed this Second Amended Intergovernmental Agreement on the date first appearing above.

**CITY OF FORT COLLINS, COLORADO,
a municipal corporation**

By: _____
Darin Atteberry, City Manager

ATTEST:

By: _____
City Clerk

APPROVED AS TO FORM:

By: _____
Assistant City Attorney

TOWN OF WINDSOR, a Colorado municipal corporation

By: _____
Kelly E. Arnold, Town Manager

ATTEST:

By: _____
City Clerk

APPROVED AS TO FORM:

By: _____
City Attorney

Report of Bills

October 2016



TOWN OF WINDSOR
301 WALNUT STREET
Windsor, CO 80550
WWW.WINDSORGOV.COM

(970) 674-2400
MON-FRI 8AM TO 5PM

Check No.	Vendor/Employee	Transaction Description	Date	Amount
Fund: 01 GENERAL FUND				
Department: 000 NO PROJECT CODE				
78316	WELD COUNTY DRUG TASK FORCE	WINDSOR MUNICIPAL COURT COLLECTIONS	10/07/2016	1,071.00
78334	UNITED WAY OF WELD COUNTY	EMPLOYEE DONATIONS	10/07/2016	15.00
78335	FAMILY SUPPORT REGISTRY	WAGE ASSIGNMENTS	10/07/2016	276.92
78336	FAMILY SUPPORT REGISTRY	WAGE ASSIGNMENTS	10/07/2016	296.57
78377	OKLAHOMA CENTRALIZED SUPPORT REGISTRY	WAGE ASSIGNMENTS	10/07/2016	156.85
78380	GC SERVICES, LP	WAGE ASSIGNMENT	10/07/2016	198.18
78384	COLORADO DEPARTMENT OF REVENUE	WAGE ASSIGNMENT	10/07/2016	83.81
78398	WELD COUNTY DRUG TASK FORCE	MUNICIPAL COURT FINE SURCHARGES	10/14/2016	1,239.00
78439	COLORADO DEPARTMENT OF REVENUE	SALES TAX	10/14/2016	251.00
78453	CENTERPOINTE DEVELOPMENT GROUP	REIMBURSEMENT OF ADMIN FEE	10/14/2016	432.54
78454	TOWN OF WINDSOR SALES TAX	SALES TAX - CRC	10/14/2016	345.90
78477	LARIMER COUNTY SALES AND USE TAX	LARIMER COUNTY USE TAX COLLECTIONS	10/21/2016	11,550.94
78483	UNITED WAY OF WELD COUNTY	EMPLOYEE DONATIONS	10/21/2016	15.00
78484	FAMILY SUPPORT REGISTRY	WAGE ASSIGNMENT	10/21/2016	296.57
78485	FAMILY SUPPORT REGISTRY	WAGE ASSIGNMENT	10/21/2016	276.92
78500	SAFEBUILT INC.	BUILDING PERMIT REIMBURSEMENTS	10/21/2016	150,028.74
78501	MARY CARSON-ROBINS	REIMBURSE OVERPMT OF FICA TAX - DEDUC	10/21/2016	27.94
78522	RICHMOND AMERICAN HOMES OF COLORADO, INC	BUILDING PERMIT REFUND	10/21/2016	2,239.84
78525	OKLAHOMA CENTRALIZED SUPPORT REGISTRY	WAGE ASSIGNMENT	10/21/2016	156.85
78527	GC SERVICES, LP	WAGE ASSIGNMENT	10/21/2016	246.21
78530	COLORADO DEPARTMENT OF REVENUE	WAGE ASSIGNMENT	10/21/2016	18.67
78532	WINDSOR COMMUNITY CHURCH	REFUND PARTIAL PLAN REVIEW & ELECTRIC	10/21/2016	116.00
78533	SAINT AUBYN HOMES, LLC	REFUND PLAN REVIEW FEE - 16WIN-01124.011	10/21/2016	763.30
78558	AFLAC	EMPLOYEE BENEFITS - OCT	10/28/2016	888.64
78606	JENNIFER THOMPSON	REFUND MV SLAES TAX -LARIMER CTY	10/28/2016	9.00
78612	CENTURY COMMUNITIES, INC	BUILDING PERMIT REFUND - 8301 WYNSTON	10/28/2016	3,564.91
Total for Department: 000 NO PROJECT CODE				174,566.30
Department: 410 TOWN CLERK/CUSTOMER				
78305	COREN PRINTING, INC.	BUILDING PERMIT BUSINESS CARDS	10/07/2016	96.00
78327	OFFICE DEPOT	OFFICE SUPPLIES	10/07/2016	29.95
78350	PITNEY BOWES	POSTAL LEASE	10/07/2016	18.38
78352	GREELEY TRIBUNE	ORDINANCE 2016-1524 2ND	10/07/2016	34.30
78367	ABLAO LAW LLC	LIQUOR AUTHORITY 3RD QUARTER 2016	10/07/2016	611.25
78407	OFFICE DEPOT	OFFICE SUPPLIES	10/14/2016	10.91
78495	CENTURY LINK	PHONE SERVICE - LONG DISTANCE	10/14/2016	14.92
78506	CARD SERVICES	CONFERENCE REGISTRATION	10/21/2016	294.22
78517	DISCOVERY BENEFITS, INC	MSA ADMINISTRATION	10/21/2016	14.70
Total for Department: 410 TOWN CLERK/CUSTOM				1,124.63
Department: 411 MAYOR & TOWN BOARD				
78419	ALPHAGRAPHICS	HARVEST FEST DISPLAY BOARD	10/14/2016	58.52
78433	KRISTIE MELENDEZ	MILEAGE REIMBURSEMENT - MAYOR'S SUMI	10/14/2016	92.22
78465	WINDSOR CHAMBER OF COMMERCE	TOWN BOARD AND GUEST CHAMBER ANNU/	10/21/2016	280.00
78506	CARD SERVICES	COFFEE WITH MAYOR	10/21/2016	173.87
Total for Department: 411 MAYOR & TOWN BOAR				604.61
Department: 412 MUNICIPAL COURT				
78311	MICHAEL E MANNING	MUNICIPAL COURT JUDGE SERVICE	10/07/2016	1,410.00
78350	PITNEY BOWES	POSTAL LEASE	10/07/2016	26.29
78495	CENTURY LINK	PHONE SERVICE - LONG DISTANCE	10/21/2016	4.74
Total for Department: 412 MUNICIPAL COURT				1,441.03
Department: 413 TOWN MANAGER				
78350	PITNEY BOWES	POSTAL LEASE	10/07/2016	5.98
78407	OFFICE DEPOT	OFFICE SUPPLIES	10/14/2016	10.91
78429	ROTARY CLUB OF WINDSOR	MEMBERSHIP DUES / LUNCHES	10/14/2016	175.00
78442	RENEE MULLINEX	TIER 1 WINNER	10/14/2016	25.00
78451	NATALIE CUELLAR	TIER 2 WINNER	10/14/2016	100.00
78465	WINDSOR CHAMBER OF COMMERCE	ARNOLD AND UNGER ANNUAL DINNER	10/21/2016	80.00
78471	VARTEC TELECOM	FAX MACHINE	10/21/2016	1.26
78495	CENTURY LINK	PHONE SERVICE - LONG DISTANCE	10/21/2016	8.36
78506	CARD SERVICES	GREELEY TRIBUNE & COLORADOAN WEB AC	10/21/2016	362.54
78517	DISCOVERY BENEFITS, INC	MSA ADMINISTRATION	10/21/2016	4.90
78535	THE RANCH	EMPLOYEE BANQUET DEPOSIT	10/21/2016	268.75
Total for Department: 413 TOWN MANAGER				1,042.70

Check No.	Vendor/Employee	Transaction Description	Date	Amount
Department: 415 FINANCE				
78327	OFFICE DEPOT	OFFICE SUPPLIES	10/07/2016	51.18
78350	PITNEY BOWES	POSTAL LEASE	10/07/2016	165.21
78407	OFFICE DEPOT	OFFICE SUPPLIES	10/14/2016	107.97
78471	VARTEC TELECOM	FAX MACHINE	10/21/2016	1.26
78495	CENTURY LINK	PHONE SERVICE - LONG DISTANCE	10/21/2016	13.05
78506	CARD SERVICES	CFGOA CONFERENCE REGISTRATION	10/21/2016	275.00
78517	DISCOVERY BENEFITS, INC	MSA ADMINISTRATION	10/21/2016	24.50
78574	BANK OF COLORADO	RESTOCK GIFTCARD INVENTORY	10/28/2016	200.00
Total for Department: 415 FINANCE				838.17
Department: 416 HUMAN RESOURCES				
78305	COREN PRINTING, INC.	PRINTING COST	10/07/2016	108.00
78306	VERIZON WIRELESS SERVICES LLC	CELL PHONE SERVICE	10/07/2016	36.27
78310	WINDSOR LIL FLOWER SHOP	FLOWERS	10/07/2016	157.90
78348	HIRERIGHT, LLC	BACKGROUND SCREENINGS	10/07/2016	1,105.50
78350	PITNEY BOWES	POSTAL LEASE	10/07/2016	14.14
78392	WINDSOR LIL FLOWER SHOP	Employee Relations	10/14/2016	399.75
78394	PETTY CASH	IT FINGERPRINTS	10/14/2016	42.57
78407	OFFICE DEPOT	OFFICE SUPPLIES	10/14/2016	348.98
78415	KING SOOPERS	REFRESHMENTS - EMPLOYEE LAST DAY	10/14/2016	35.49
78495	CENTURY LINK	PHONE SERVICE - LONG DISTANCE	10/21/2016	15.62
78501	MARY CARSON-ROBINS	REIMBURSE OVERPMT OF FICA TAX - DEDUC	10/21/2016	-13.97
78506	CARD SERVICES	FUNERAL FLOWERS AND EMPLOYEE CELEB	10/21/2016	1,469.72
78510	COLORADO HEALTH MEDICAL GROUP	DRUG SCREEN	10/21/2016	63.00
78517	DISCOVERY BENEFITS, INC	MSA ADMINISTRATION	10/21/2016	4.90
78561	OFFICE DEPOT	OFFICE SUPPLIES	10/28/2016	27.18
78591	JACQUELYNE KREMSER	MILEAGE REIMBURSEMENT	10/28/2016	82.19
Total for Department: 416 HUMAN RESOURCES				3,897.24
Department: 418 LEGAL SERVICES				
78350	PITNEY BOWES	POSTAL LEASE	10/07/2016	0.87
78407	OFFICE DEPOT	OFFICE SUPPLIES	10/14/2016	10.91
78495	CENTURY LINK	PHONE SERVICE - LONG DISTANCE	10/21/2016	8.08
78506	CARD SERVICES	CLE INTERNATIONAL	10/21/2016	795.00
78514	WEST PUBLISHING CORPORATION	West Law Subscription--09/01/2016-09/30/2016	10/21/2016	720.35
78517	DISCOVERY BENEFITS, INC	MSA ADMINISTRATION	10/21/2016	9.80
Total for Department: 418 LEGAL SERVICES				1,545.01
Department: 419 PLANNING & ZONING				
78320	LARIMER COUNTY CLERK AND RECORDER	FILING FEES	10/07/2016	107.00
78350	PITNEY BOWES	POSTAL LEASE	10/07/2016	13.77
78352	GREELEY TRIBUNE	PH CAC DESIGN STANDARDS	10/07/2016	40.60
78407	OFFICE DEPOT	OFFICE SUPPLIES	10/14/2016	99.83
78471	VARTEC TELECOM	FAX MACHINE	10/21/2016	1.26
78495	CENTURY LINK	PHONE SERVICE - LONG DISTANCE	10/21/2016	17.44
78506	CARD SERVICES	APA CONFERENCE REIMBURSEMENT	10/21/2016	-275.00
78517	DISCOVERY BENEFITS, INC	MSA ADMINISTRATION	10/21/2016	19.60
Total for Department: 419 PLANNING & ZONING				24.50
Department: 420 ECONOMIC DEVELOPMENT				
78327	OFFICE DEPOT	OFFICE SUPPLIES	10/07/2016	17.86
78350	PITNEY BOWES	POSTAL LEASE	10/07/2016	1.81
78407	OFFICE DEPOT	OFFICE SUPPLIES	10/14/2016	10.91
78495	CENTURY LINK	PHONE SERVICE - LONG DISTANCE	10/21/2016	14.34
78506	CARD SERVICES	SITE SELECTION MEETING	10/21/2016	967.90
78517	DISCOVERY BENEFITS, INC	MSA ADMINISTRATION	10/21/2016	9.80
Total for Department: 420 ECONOMIC DEVELOPM				1,022.62

Check No.	Vendor/Employee	Transaction Description	Date	Amount
Department: 421 POLICE DEPARTMENT				
78305	COREN PRINTING, INC.	NAME PINS/DODD, ZEIGLER, KLIMEK	10/07/2016	708.00
78306	VERIZON WIRELESS SERVICES LLC	CELL PHONE SERVICE	10/07/2016	1,502.81
78313	CENTURYLINK	PHONE SERVICE	10/07/2016	307.53
78324	BUNTING DISPOSAL, INC.	TRASH SERVICE	10/07/2016	76.00
78328	MAIL N COPY	RADAR SENT FOR REPAIR	10/07/2016	73.91
78350	PITNEY BOWES	POSTAL LEASE	10/07/2016	88.52
78392	WINDSOR L'I'L FLOWER SHOP	PLANT TO M DOUGLAS	10/14/2016	63.38
78394	PETTY CASH	BREAK ROOM SUPPLIES	10/14/2016	59.24
78407	OFFICE DEPOT	OFFICE SUPPLIES	10/14/2016	168.55
78422	KINSCO, LLC	FLASHLIGHT HOLDER/RADIO HOLDERS X2 F	10/14/2016	105.47
78426	BRENT HOGSETT	OFF DUTY HOLSTER	10/14/2016	85.27
78428	CREATIVE CULTURE INSIGNIA, LLC	BADGES/R PURVIS/C DODD/R ZEIGLER	10/14/2016	448.25
78430	STALKER RADAR	RADAR REPAIR/AS007732	10/14/2016	80.00
78450	CNC TECHNICAL SERVICES, LLC	RADIOS AND EQUIPMENT FOR COLO RANGEI	10/14/2016	3,650.00
78465	WINDSOR CHAMBER OF COMMERCE	KLIMEK ANNUAL DINNER	10/21/2016	40.00
78467	CIRSA	WORKERS COMP	10/21/2016	-73.47
78474	BUNTING DISPOSAL, INC.	TRASH SERVICE	10/21/2016	76.00
78495	CENTURY LINK	PHONE SERVICE - LONG DISTANCE	10/21/2016	38.82
78506	CARD SERVICES	BATTERIES & OFFICE SUPPLIES	10/21/2016	495.67
78517	DISCOVERY BENEFITS, INC	MSA ADMINISTRATION	10/21/2016	29.40
78550	CHEMATOX LABORATORY INC	BLOOD ALCOHOL TEST/16-10618	10/28/2016	25.00
78552	XCEL ENERGY	UTILITIES	10/28/2016	1,716.40
78561	OFFICE DEPOT	OFFICE SUPPLIES	10/28/2016	131.91
78575	THE HUMANE SOCIETY OF WELD COUNTY	ANIMAL CARE AND HOUSING/16-10535	10/28/2016	129.84
78576	GARDEN VALLEY VET HOSPITAL	PET RECOVERY/BOARDING/16-12537	10/28/2016	150.00
78578	POUDRE VALLEY HEALTH SYSTEM	SECURE BLOOD DRA/W/16-10618	10/28/2016	136.24
78613	ROYAL VISTA VETERINARY SPECIALISTS, LLC	DOG EMERGENCY CARE	10/28/2016	195.00
Total for Department: 421 POLICE DEPARTMENT				10,507.74
Department: 428 RECYCLING				
78369	ULTIMATE SPECIALTIES LLC	PM SERVICE ON RECYCLING COMPACTORS	10/07/2016	462.20
78390	WASTE MANAGEMENT OF COLORADO	RECYCLE SITE PULLS	10/14/2016	1,348.52
78552	XCEL ENERGY	UTILITIES	10/28/2016	44.28
Total for Department: 428 RECYCLING				1,855.00
Department: 429 STREETS & ALLEYS				
78306	VERIZON WIRELESS SERVICES LLC	CELL PHONE SERVICE	10/07/2016	40.01
78307	VERIZON WIRELESS SERVICES LLC	TOWN BILL BOARDS	10/07/2016	92.32
78308	GENERAL AIR SERVICE AND SUPPLY CO	SHOP WELDER AND SUPPLIES	10/07/2016	2,532.84
78395	XCEL ENERGY	UTILITIES	10/14/2016	24,569.64
78402	POUDRE VALLEY RURAL ELECTRIC ASSOCIATION	UTILITIES	10/14/2016	79.41
78424	COLORADO ASPHALT SERVICES, INC	ASPHALT IN A BAG	10/14/2016	1,788.00
78459	FORT COLLINS-LOVELAND WATER DISTRICT	WATER PURCHASED	10/21/2016	296.63
78473	POUDRE VALLEY RURAL ELECTRIC ASSOCIATION	UTILITIES	10/21/2016	6,815.46
78557	POUDRE VALLEY RURAL ELECTRIC ASSOCIATION	UTILITIES	10/28/2016	2,748.28
Total for Department: 429 STREETS & ALLEYS				38,962.59
Department: 430 PUBLIC WORKS				
78306	VERIZON WIRELESS SERVICES LLC	CELL PHONE SERVICE	10/07/2016	32.21
78312	XCEL ENERGY	UTILITIES	10/07/2016	935.88
78324	BUNTING DISPOSAL, INC.	TRASH SERVICE	10/07/2016	68.00
78350	PITNEY BOWES	POSTAL LEASE	10/07/2016	35.63
78391	GENERAL AIR SERVICE AND SUPPLY CO	WELDING SUPPLIES	10/14/2016	85.27
78421	AT&T MOBILITY II LLC	ALERT MONITORS WIRELESS SERVICE	10/14/2016	87.20
78464	CENTURYLINK	PHONE SERVICE	10/21/2016	48.75
78465	WINDSOR CHAMBER OF COMMERCE	WALKER ANNUAL DINNER	10/21/2016	40.00
78471	VARTEC TELECOM	FAX MACHINE	10/21/2016	1.26
78474	BUNTING DISPOSAL, INC.	TRASH SERVICE	10/21/2016	68.00
78478	OFFICE DEPOT	COFFEE	10/21/2016	87.27
78495	CENTURY LINK	PHONE SERVICE - LONG DISTANCE	10/21/2016	9.08
78506	CARD SERVICES	TRAINING LUNCH	10/21/2016	191.98
78517	DISCOVERY BENEFITS, INC	MSA ADMINISTRATION	10/21/2016	4.90
78561	OFFICE DEPOT	BATTERIES	10/28/2016	102.86
Total for Department: 430 PUBLIC WORKS				1,798.29
Department: 431 ENGINEERING DEPARTMENT				
78350	PITNEY BOWES	POSTAL LEASE	10/07/2016	16.32
78407	OFFICE DEPOT	OFFICE SUPPLIES	10/14/2016	15.14
78465	WINDSOR CHAMBER OF COMMERCE	WAGNER ANNUAL DINNER	10/21/2016	40.00
78471	VARTEC TELECOM	FAX MACHINE	10/21/2016	1.26
78495	CENTURY LINK	PHONE SERVICE - LONG DISTANCE	10/21/2016	16.23
78517	DISCOVERY BENEFITS, INC	MSA ADMINISTRATION	10/21/2016	29.40
78554	USA BLUE BOOK	HYDRANT SAMPLING KIT	10/28/2016	91.05
Total for Department: 431 ENGINEERING				209.40

Check No.	Vendor/Employee	Transaction Description	Date	Amount
Department: 432 CEMETERY				
78324	BUNTING DISPOSAL, INC.	TRASH SERVICE	10/07/2016	30.00
78342	DBC IRRIGATION SUPPLY	SPRINKLER PARTS	10/07/2016	1,902.77
78347	PIONEER SAND COMPANY	SAND	10/07/2016	837.45
78372	ADVANCED MECHANICAL SERVICES, INC	REPAIR PUMP AT CHIMNEY PARK	10/07/2016	4,300.00
78385	HAROLD HINKLEY	SELL BACK TO TOWN - LOT 79 SPACE 1.3,5.7	10/07/2016	2,200.00
78386	AFFORDABLE FUNERAL SUPPLY, LLC	OUTRIGGER PADS	10/07/2016	763.85
78434	GREEN LAWN SOD CO, INC	BLUEGRASS	10/14/2016	153.10
78461	MANWEILER HARDWARE, INC	HOOKS & GOOP	10/21/2016	19.93
78474	BUNTING DISPOSAL, INC.	TRASH SERVICE	10/21/2016	30.00
78506	CARD SERVICES	SNOW & ICE CONFERENCE	10/21/2016	110.00
78517	DISCOVERY BENEFITS, INC	MSA ADMINISTRATION	10/21/2016	4.90
78552	XCEL ENERGY	UTILITIES	10/28/2016	679.18
Total for Department: 432 CEMETERY				11,031.18
Department: 433 COMMUNITY EVENTS				
78495	CENTURY LINK	PHONE SERVICE - LONG DISTANCE	10/21/2016	2.85
78506	CARD SERVICES	STAFF MEETING	10/21/2016	251.94
Total for Department: 433 COMMUNITY EVENTS				254.79
Department: 450 FORESTRY				
78322	ARAPAHOE RENTAL	STUMP GRINDER RENTAL	10/07/2016	133.75
78403	VICTORY SALES, INC	UNIFORMS	10/14/2016	268.50
78467	CIRSA	WORKERS COMP	10/21/2016	725.81
78492	GULLEY GREENHOUSE, INC.	FALL ANNUALS	10/21/2016	233.26
78495	CENTURY LINK	PHONE SERVICE - LONG DISTANCE	10/21/2016	2.85
78506	CARD SERVICES	SNOW & ICE CONFERENCE	10/21/2016	1,054.62
78586	FERGUSON ENTERPRISES, INC.	CHRISTMAS LIGHTS FOR DOWNTOWN	10/28/2016	2,638.50
78598	ALISON O'CONNOR	REIMBURSE PARADE SUPPLIES	10/28/2016	54.22
78616	TONY KOSKI	REIMBURSE CANDY FOR HARVEST FEST PAR	10/28/2016	57.22
Total for Department: 450 FORESTRY				5,168.73
Department: 451 RECREATION				
78315	CIRSA	WC CLAIMS	10/07/2016	1,000.00
78321	VICTORY SALES, INC	MUD VOLLEY BALL SHIRTS	10/07/2016	2,745.60
78322	ARAPAHOE RENTAL	PROPANE TANK REFILL	10/07/2016	44.95
78325	LL JOHNSON DISTRIBUTING CO.	FIELD PAINT	10/07/2016	2,020.00
78328	MAIL N COPY	LAMINATING PARKING SIGNS FOR MUD VOL	10/07/2016	44.70
78344	NAPA AUTO PARTS	DOOR PRIZES FOR WINDOR CRUISE IN	10/07/2016	345.39
78346	KING SOOPERS	PARADE WATER FOR UPWARD	10/07/2016	283.95
78350	PITNEY BOWES	POSTAL LEASE	10/07/2016	45.04
78355	POWER TO PLAY SPORTS LLC	LEAGUE FALL - 1 TEAM	10/07/2016	1,175.00
78356	SAI NORTH TEAM SPORTS	SOCCER CORNER FLAGS	10/07/2016	727.70
78358	MUTSUMI PAULINE BROWN	FITNESS CLASS - SEPTEMBER	10/07/2016	672.00
78360	FORT COLLINS SOCCER CLUB	FALL TRAVEL SOCCER DUES	10/07/2016	825.00
78371	DANNI DANCE CORP	DANCE CLASS	10/07/2016	1,000.00
78381	KRISTINA, K. WOOD	FITNESS CLASSES	10/07/2016	125.00
78382	JC LYNNE & CO LLC	FITNESS CLASS - SEPTEMBER	10/07/2016	550.00
78401	COLORADO PARKS AND RECREATION ASSOCIATION	MARKETING	10/14/2016	125.00
78441	DENEICE J DYER	SEPTEMBER CLASSES	10/14/2016	224.00
78443	MOUNTAIN SONG MUSIC STUDIO, INC	MUSIC TOGETHER FALL SESSION I & II	10/14/2016	2,473.80
78449	DEBORAH L. CAMPBELL	FITNESS CLASSES OCT 6-13	10/14/2016	75.00
78461	MANWEILER HARDWARE, INC	PAINT SUPPLIES	10/21/2016	422.18
78463	GARRETSON'S SPORT CENTER	MENS SOFTBALLS	10/21/2016	773.36
78475	LL JOHNSON DISTRIBUTING CO.	FIELD PAINT	10/21/2016	512.00
78493	SEAN GROGAN	ASB FALL COED & MEN'S TOURNAMENTS	10/21/2016	4,554.00
78495	CENTURY LINK	PHONE SERVICE - LONG DISTANCE	10/21/2016	32.70
78499	BSN SPORTS INC	SOCCER CORNER SET & SOCCETS	10/21/2016	952.00
78506	CARD SERVICES	CONSTANT CONTACT	10/21/2016	1,075.23
78517	DISCOVERY BENEFITS, INC	MSA ADMINISTRATION	10/21/2016	19.60
78519	UNITED SITE SERVICES OF COLORADO, INC	PORTABLE RESTROOMS	10/21/2016	525.00
78526	WINDSOR YOUTH CHEER	REC CHEER TEAMS	10/21/2016	6,342.00
78529	DEBORAH L. CAMPBELL	FITNESS CLASSES	10/21/2016	50.00
78596	HUGO A FLORES	TEEN NIGHT - SEPTEMBER	10/28/2016	300.00
78600	UNITED SITE SERVICES OF COLORADO, INC	PORTABLE RESTROOMS	10/28/2016	61.00
78607	KRISTINA, K. WOOD	FITNESS CLASS 10/2 - 10/15	10/28/2016	187.00
78609	KELLY MARIE KENNEDY	FITNESS CLASSES 10/1 - 10/14	10/28/2016	150.00
78610	LINDA ZIEGLER	FITNESS CLASS 10/13 - 10/25	10/28/2016	325.00
78615	KEVIN G. HINKLE	PERSONAL TRAINING 10/10 - 10/23	10/28/2016	1,034.24
Total for Department: 451 RECREATION				31,817.44

Check No.	Vendor/Employee	Transaction Description	Date	Amount
Department: 452 AQUATICS/SWIMMING POOL				
78329	ENVIROPEST	PEST CONTROL AT CPP	10/07/2016	129.00
78331	WHOLESALE DISTRIBUTION ALLIANCE LTD	TEST TUBES	10/07/2016	2,036.35
78395	XCEL ENERGY	UTILITIES	10/14/2016	1,836.06
78456	IN THE SWIM	BAHIA CHAISE CHAIRS	10/14/2016	779.94
78464	CENTURYLINK	PHONE SERVICE	10/21/2016	126.37
78472	COLORADO PARKS AND RECREATION ASSOCIATION	2016 CARA SWIM WINTER / SPRING HOSTING	10/21/2016	374.50
78495	CENTURY LINK	PHONE SERVICE - LONG DISTANCE	10/21/2016	2.85
78506	CARD SERVICES	STARFISH AQUATICS INSTITUTES	10/21/2016	78.57
78507	ISLAND LAKE MARINE & SPORTS, INC	WINTERIZE BOAT FOR LAKE	10/21/2016	313.97
78512	HAYNEEDLE, INC	CRC EXPANSION SUPPLIES	10/21/2016	3,624.94
78537	SWIMOUTLET.COM	SPORTI PADDLE REPLACEMENT TUBING	10/21/2016	29.50
Total for Department: 452 AQUATICS/SWIMMING				9,332.05
Department: 454 PARKS				
78306	VERIZON WIRELESS SERVICES LLC	CELL PHONE SERVICE	10/07/2016	40.01
78312	XCEL ENERGY	UTILITIES	10/07/2016	9,662.87
78313	CENTURYLINK	PHONE SERVICE	10/07/2016	36.86
78322	ARAPAHOE RENTAL	PIPE PULLER	10/07/2016	152.45
78324	BUNTING DISPOSAL, INC.	TRASH SERVICE	10/07/2016	529.00
78328	MAL N COPY	POSTAGE	10/07/2016	3.84
78329	ENVIROPEST	PEST CONTROL - CHIMNEY PARK	10/07/2016	882.00
78347	PIONEER SAND COMPANY	ROCK	10/07/2016	48.75
78350	PITNEY BOWES	POSTAL LEASE	10/07/2016	17.57
78372	ADVANCED MECHANICAL SERVICES, INC	REPAIR FILTERS AT EASTMAN PARK	10/07/2016	1,125.00
78393	MICHAEL TODD AND COMPANY, INC.	GRIPPER TOOL	10/14/2016	279.70
78404	ARAPAHOE RENTAL	PROPANE	10/14/2016	17.85
78409	WINDSOR-SEVERANCE FIRE PROTECT	MUSEUM UTILITY EXPENSE - TOWN PORTIOI	10/14/2016	31.75
78411	HOME DEPOT	RACHET TIE DOWNS	10/14/2016	95.27
78416	PIONEER SAND COMPANY	ROCK	10/14/2016	517.02
78459	FORT COLLINS-LOVELAND WATER DISTRICT	WATER PURCHASED	10/21/2016	2,001.15
78461	MANWEILER HARDWARE, INC	PARKS CHARGES	10/21/2016	231.82
78471	VARTEC TELECOM	FAX MACHINE	10/21/2016	1.26
78473	POUDRE VALLEY RURAL ELECTRIC ASSOCIATION	UTILITIES	10/21/2016	36.98
78474	BUNTING DISPOSAL, INC.	TRASH SERVICE	10/21/2016	529.00
78478	OFFICE DEPOT	COFFEE	10/21/2016	87.27
78489	DBC IRRIGATION SUPPLY	SERVICE CHARGE	10/21/2016	20.51
78494	PIONEER SAND COMPANY	COBBLESTONE	10/21/2016	128.85
78495	CENTURY LINK	PHONE SERVICE - LONG DISTANCE	10/21/2016	5.40
78496	QUALITY DOOR, INC	INSTALL KEYLESS ENTRY	10/21/2016	892.00
78506	CARD SERVICES	CERTIFICATION CLASS	10/21/2016	1,321.46
78511	L AND M ENTERPRISES INC	LANDSCAPE MAINTENANCE	10/21/2016	2,252.17
78517	DISCOVERY BENEFITS, INC	MSA ADMINISTRATION	10/21/2016	14.70
78551	MIRACLE RECREATION EQUIPMENT C	SLIDE LEG	10/28/2016	113.59
78561	OFFICE DEPOT	BATTERIES	10/28/2016	102.86
78565	K AND W PRINTING, INC	SIGNS	10/28/2016	250.00
78570	PIONEER SAND COMPANY	ROCK	10/28/2016	79.75
78579	GOLF AND SPORT SOLUTIONS, LLC	DEEPTINE AERATION	10/28/2016	1,220.00
78581	NEW WINDSOR METROPOLITAN DISTRICT	WATERING SCHEDULE	10/28/2016	2,461.48
78600	UNITED SITE SERVICES OF COLORADO, INC	PORTABLE RESTROOMS	10/28/2016	1,010.00
78605	ECO-COUNTER, INC.	ECO-COUNTER REPAIR	10/28/2016	628.50
Total for Department: 454 PARKS				26,828.69
Department: 456 ART & HERITAGE				
78312	XCEL ENERGY	UTILITIES	10/07/2016	506.00
78313	CENTURYLINK	PHONE SERVICE	10/07/2016	51.57
78349	DIGI PIX SIGNS	REFLECTION SIGN	10/07/2016	175.38
78350	PITNEY BOWES	POSTAL LEASE	10/07/2016	3.92
78452	JOYCE B. LOHSE	SPEAKER SERIES - HONORARIUM	10/14/2016	100.00
78464	CENTURYLINK	PHONE SERVICE	10/21/2016	186.39
78471	VARTEC TELECOM	FAX MACHINE	10/21/2016	1.26
78495	CENTURY LINK	PHONE SERVICE - LONG DISTANCE	10/21/2016	2.98
Total for Department: 456 ART & HERITAGE				1,027.50
Department: 457 TOWN HALL				
78313	CENTURYLINK	PHONE SERVICE	10/07/2016	132.92
78462	XCEL ENERGY	UTILITIES	10/21/2016	2,286.06
78464	CENTURYLINK	PHONE SERVICE	10/21/2016	696.46
Total for Department: 457 TOWN HALL				3,115.44
Total for Fund:01 GENERAL FUND				328,015.65

Check No.	Vendor/Employee	Transaction Description	Date	Amount
Fund: 02 PARK IMPROVEMENT FUND				
Department: 000 NO PROJECT CODE				
78522	RICHMOND AMERICAN HOMES OF COLORADO, INC	BUILDING PERMIT REFUND	10/21/2016	4,962.00
78603	RICHMOND AMERICAN HOMES OF COLORADO, INC	REFUND FOR OVERCHGD NEIGHBORHOOD P	10/28/2016	1,734.00
78612	CENTURY COMMUNITIES, INC	BUILDING PERMIT REFUND - 8301 WYNSTON	10/28/2016	4,962.00
Total for Department: 000 NO PROJECT CODE				11,658.00
Total for Fund:02 PARK IMPROVEMENT FUND				11,658.00
Fund: 03 CONSERVATION TRUST FUND				
Department: 454 PARKS				
78588	MOUNTAIN CONSTRUCTORS, INC	CR 19 TRAIL CROSSING @ #2 DITCH TRAIL IM	10/28/2016	10,815.80
Total for Department: 454 PARKS				10,815.80
Total for Fund:03 CONSERVATION TRUST FUND				10,815.80
Fund: 04 CAPITAL IMPROVEMENT FUND				
Department: 000 NO PROJECT CODE				
78522	RICHMOND AMERICAN HOMES OF COLORADO, INC	BUILDING PERMIT REFUND	10/21/2016	6,962.21
78583	DR HORTON	REFUND ROAD IMPACT FEE - 2171 LONGFIN I	10/28/2016	3.00
78602	RICHMOND AMERICAN HOMES OF COLORADO, INC	REFUND ROAD IMPACT FEE - 1664 SORENSON	10/28/2016	100.00
78606	JENNIFER THOMPSON	REFUND MV SLAES TAX -LARIMER CTY	10/28/2016	6.00
78612	CENTURY COMMUNITIES, INC	BUILDING PERMIT REFUND - 8301 WYNSTON	10/28/2016	7,128.33
Total for Department: 000 NO PROJECT CODE				14,199.54
Department: 429 STREETS & ALLEYS				
78370	TST, INC CONSULTING ENGINEERS	NEW LIBERTY ROAD DESIGN	10/07/2016	5,112.70
78379	DCP CIVIL LLC	NEW LIBERTY ROAD EXTENSION	10/07/2016	135,795.48
78431	EARTH ENGINEERING CONSULTANTS, LLC	NEW LIBERTY ROAD EXTENSION GEOTECHN	10/14/2016	1,106.25
78447	COLORADO CIVIL GROUP, INC	COUNTY LINE DITCH EROSION DESIGN	10/14/2016	10,873.50
78448	DCP CIVIL LLC	NEW LIBERTY ROAD EXTENSION	10/14/2016	193,682.25
78564	FELSBURG HOLT AND ULLEVIG, INC	QUIET ZONE PLANNING / ADMIN	10/28/2016	426.20
78577	A-1 CHIPSEAL CO	SLURRY SEAL	10/28/2016	45,357.27
78582	EARTH ENGINEERING CONSULTANTS, LLC	NEW LIBERTY ROAD EXTENSION GEOTECHN	10/28/2016	630.50
78595	WL CONTRACTORS, INC	WCR13 / CROSSROADS BLVD SIGNAL CONSTI	10/28/2016	11,219.39
78601	WALSH CONSTRUCTION, INC	QUIET ZONE CONSTRUCTION	10/28/2016	187,285.63
78604	CTC, INC.	QUIET ZONE CONSTRUCTION	10/28/2016	63,780.54
Total for Department: 429 STREETS & ALLEYS				655,269.71
Department: 430 PUBLIC WORKS				
78309	KING SURVEYORS, INC.	PW/MAINT FACILITY CALCULATE AND STAK	10/07/2016	449.00
78359	EARTH ENGINEERING CONSULTANTS, LLC	PW MAINT FACILITY / GEOTECHNICLA RERP	10/07/2016	750.00
78374	INFUSION ARCHITECTS, LLC	PW MAINT FACILITY / ARCHITECTS	10/07/2016	4,635.00
78531	OMNITRAX INC	4" FIBER OPTIC #3 PIPELINE CROSSING RAILF	10/21/2016	9,450.00
Total for Department: 430 PUBLIC WORKS DEPAR				15,284.00
Department: 431 ENGINEERING DEPARTMENT				
78478	OFFICE DEPOT	SCAN DISK FLASH DRIVE	10/21/2016	24.62
Total for Department: 431 ENGINEERING DEPART				24.62
Department: 456 ART & HERITAGE				
78378	THE COLLABORATIVE, INC.	EATON HOUSE HISTORIC STRUCTURE ASSES	10/07/2016	1,590.00
Total for Department: 456 ART & HERITAGE				1,590.00
Total for Fund:04 CAPITAL IMPROVEMENT FUND				686,367.87

Check No.	Vendor/Employee	Transaction Description	Date	Amount
Fund: 05 COMMUNITY & REC CENTER FUND				
Department: 000 NO PROJECT CODE				
78522	RICHMOND AMERICAN HOMES OF COLORADO, INC	BUILDING PERMIT REFUND	10/21/2016	323.15
78606	JENNIFER THOMPSON	REFUND MV SLAES TAX -LARIMER CTY	10/28/2016	1.00
78612	CENTURY COMMUNITIES, INC	BUILDING PERMIT REFUND - 8301 WYNSTON	10/28/2016	334.22
78614	JEREMY BASEMAN	RECREATION REFUND	10/28/2016	375.00
Total for Department: 000 NO PROJECT CODE				1,033.37
Department: 490 COMMUNITY RECREATION				
78306	VERIZON WIRELESS SERVICES LLC	CELL PHONE SERVICE	10/07/2016	29.29
78321	VICTORY SALES, INC	CLOTHING	10/07/2016	874.50
78324	BUNTING DISPOSAL, INC.	TRASH SERVICE	10/07/2016	155.00
78327	OFFICE DEPOT	OFFICE SUPPLIES	10/07/2016	148.07
78350	PITNEY BOWES	POSTAL LEASE	10/07/2016	6.35
78366	ALSCO INC	RENTAL LINENS - CHAMBER OF COMMERCE	10/07/2016	83.10
78395	XCEL ENERGY	UTILITIES	10/14/2016	195.46
78414	TARA FOTSCH	RENTAL CAR REIMBURSEMENT	10/14/2016	180.24
78445	4IMPRINT, INC	BAGS FOR GRAND OPENING	10/14/2016	458.44
78464	CENTURYLINK	PHONE SERVICE	10/21/2016	1,132.81
78474	BUNTING DISPOSAL, INC.	TRASH SERVICE	10/21/2016	155.00
78478	OFFICE DEPOT	OFFICE SUPPLIES	10/21/2016	74.74
78495	CENTURY LINK	PHONE SERVICE - LONG DISTANCE	10/21/2016	3.23
78506	CARD SERVICES	DIRECTOR SCHOOL GIFTS	10/21/2016	495.04
78517	DISCOVERY BENEFITS, INC	MSA ADMINISTRATION	10/21/2016	9.80
78552	XCEL ENERGY	UTILITIES	10/28/2016	14.99
78569	COMCAST CABLE COMM. LLC	INTERNET - CRC	10/28/2016	271.10
78585	FRONT RANGE POOL TABLE CO	CRC POOL TABLE MOVE & LEVEL	10/28/2016	75.00
78590	ALSCO INC	CHAMBER OF COMMERCE ANNUAL DINNER	10/28/2016	368.66
Total for Department: 490 COMMUNITY RECREAT				4,730.82
Total for Fund:05 COMMUNITY & REC CENTER F				5,764.19
Fund: 06 WATER FUND				
Department: 000 NO PROJECT CODE				
78323	GLH CONSTRUCTION, INC.	METER RENTAL REFUND	10/07/2016	2,100.00
78522	RICHMOND AMERICAN HOMES OF COLORADO, INC	BUILDING PERMIT REFUND	10/21/2016	14,000.00
78534	LIGHTHOUSE POINT TOWNHOMES, LLC	WATER METER & YOKE REFUND	10/21/2016	23,485.43
78540	Bryon & Elaine Mc Avoy	Refund Check	10/21/2016	56.10
78541	End-Ira Inc	Refund Check	10/21/2016	39.70
78544	Margaret Dodds	Refund Check	10/21/2016	10.86
78549	End-Ira Inc	Refund Check	10/21/2016	16.32
78620	Robert & Beth Hurley	Refund Check	10/28/2016	9.20
78621	CB Signature Homes	Refund Check	10/28/2016	80.42
Total for Department: 000 NO PROJECT CODE				39,798.03
Department: 471 WATER				
78305	COREN PRINTING, INC.	DELIN QUENT ENVELOPES	10/07/2016	75.67
78309	KING SURVEYORS, INC.	PW/MAINT FACILITY CALCULATE AND STAK	10/07/2016	224.50
78312	XCEL ENERGY	UTILITIES	10/07/2016	165.60
78318	UTILITY NOTIFICATION CENTER OF COLORADO	LOCATE TRANSMISSIONS	10/07/2016	903.76
78319	USA BLUE BOOK	REDI CLAMP	10/07/2016	273.23
78350	PITNEY BOWES	POSTAL LEASE	10/07/2016	150.44
78359	EARTH ENGINEERING CONSULTANTS, LLC	PW MAINT FACILITY / GEOTECHNICLA RERP	10/07/2016	375.00
78363	WELD COUNTY PUBLIC HEALTH & ENVIRONMENT	WATER SAMPLES	10/07/2016	1,720.00
78374	INFUSION ARCHITECTS, LLC	PW MAINT FACILITY / ARCHITECTS	10/07/2016	2,317.50
78379	DCP CIVIL LLC	NEW LIBERTY ROAD EXTENSION	10/07/2016	109,562.55
78396	CITY OF GREELEY WATER DEPARTMENT	WATER PURCHASED	10/14/2016	4,054.28
78402	POUDRE VALLEY RURAL ELECTRIC ASSOCIATION	UTILITIES	10/14/2016	31.33
78417	NATIONAL METER AND AUTOMATION	METERS	10/14/2016	15,145.07
78432	JVA, INCORPORATED	WATER LINE REPLACEMENT DESIGN	10/14/2016	1,800.00
78437	FARNSWORTH GROUP, INC.	WATER PUMP STATION REPAIR STUDY	10/14/2016	994.00
78448	DCP CIVIL LLC	NEW LIBERTY ROAD EXTENSION	10/14/2016	263,397.71
78458	DANA KEPNER COMPANY, INC.	METER YOKES	10/21/2016	2,238.00
78459	FORT COLLINS-LOVELAND WATER DISTRICT	WATER PURCHASED	10/21/2016	28,815.84
78466	CITY OF GREELEY WATER DEPARTMENT	WATER PURCHASED	10/21/2016	4,380.79
78473	POUDRE VALLEY RURAL ELECTRIC ASSOCIATION	UTILITIES	10/21/2016	68.64
78495	CENTURY LINK	PHONE SERVICE - LONG DISTANCE	10/21/2016	4.86
78513	INSTRUMENT AND SUPPLY WEST INC	REPAIR PRV @ KESTREL DR.	10/21/2016	1,217.50
78557	POUDRE VALLEY RURAL ELECTRIC ASSOCIATION	UTILITIES	10/28/2016	1,202.99
78572	NATIONAL METER AND AUTOMATION	METERS	10/28/2016	10,652.92
78584	BOMGAARS	UNIFORMS	10/28/2016	234.95
Total for Department: 471 WATER				450,007.13
Department: 484 NON-POTABLE				
78340	AQUA ENGINEERING, INC.	IRRIGATION SYSTEM RENOVATION	10/07/2016	275.00
78372	ADVANCED MECHANICAL SERVICES, INC	REGIONAL PUMP / GREENSPIRE PUMP REPAI	10/07/2016	8,520.00
78375	WENCK ASSOCIATES, INC	KYGER RESERVOIR PUMP STATION DESIGN	10/07/2016	10,332.00
78389	WHITNEY IRRIGATION COMPANY	DITCH MANAGEMENT	10/14/2016	2,085.00
78395	XCEL ENERGY	UTILITIES	10/14/2016	65.46
78420	CLEAR WATER SOLUTIONS INC	KERN/WCSD RE4 12-120	10/14/2016	2,340.00
78498	CLEAR WATER SOLUTIONS INC	KERN GENERAL WATER SERVICES	10/21/2016	2,614.57
78524	WENCK ASSOCIATES, INC	KYGER RESERVOIR PUMP STATION	10/21/2016	3,064.70
78557	POUDRE VALLEY RURAL ELECTRIC ASSOCIATION	UTILITIES	10/28/2016	389.77
78611	MOLTZ CONSTRUCTORS, INC.	KYGER RESERVOIR PUMP STATION - CONSTI	10/28/2016	308,052.56
Total for Department: 484 NON-POTABLE				337,739.06
Total for Fund:06 WATER FUND				827,544.22

Check No.	Vendor/Employee	Transaction Description	Date	Amount
Fund: 07 SEWER FUND				
Department: 000 NO PROJECT CODE				
78522	RICHMOND AMERICAN HOMES OF COLORADO, INC	BUILDING PERMIT REFUND	10/21/2016	4,400.00
78540	Bryon & Elaine Mc Avoy	Refund Check	10/21/2016	5.47
78542	Martin & Patzi Goldberg	Refund Check	10/21/2016	22.05
Total for Department: 000 NO PROJECT CODE				4,427.52
Department: 481 SEWER SYSTEM				
78305	COREN PRINTING, INC.	DELIN QUENT ENVELOPES	10/07/2016	75.67
78306	VERIZON WIRELESS SERVICES LLC	CELL PHONE SERVICE	10/07/2016	240.30
78309	KING SURVEYORS, INC.	PW/MAINT FACILITY CALCULATE AND STAK	10/07/2016	224.50
78312	XCEL ENERGY	UTILITIES	10/07/2016	395.66
78313	CENTURYLINK	PHONE SERVICE	10/07/2016	198.31
78350	PITNEY BOWES	POSTAL LEASE	10/07/2016	0.62
78359	EARTH ENGINEERING CONSULTANTS, LLC	PW MAINT FACILITY / GEOTECHNICLA RERP	10/07/2016	375.00
78374	INFUSION ARCHITECTS, LLC	PW MAINT FACILITY / ARCHITECTS	10/07/2016	2,317.50
78402	POUDRE VALLEY RURAL ELECTRIC ASSOCIATION	UTILITIES	10/14/2016	316.95
78406	SCOTT'S ELECTRIC AND BUCKET TRUCK SERVICE INC	SERVICE CALL - LS# 7 CHECK MOTOR	10/14/2016	210.00
78464	CENTURYLINK	PHONE SERVICE	10/21/2016	49.53
78473	POUDRE VALLEY RURAL ELECTRIC ASSOCIATION	UTILITIES	10/21/2016	34.97
78476	DALE'S ENVIRONMENTAL SERVICES,	MANHOLE REHABILITATION	10/21/2016	31,400.00
78509	FARNSWORTH GROUP, INC.	PELICAN LAKE LIFT STATEION REPLACEMEN	10/21/2016	15,800.63
78580	CUMMINS ROCKY MOUNTAIN, LLC	GENERATOR MAINTENANCE	10/28/2016	1,341.32
78584	BOMGAARS	UNIFORMS	10/28/2016	49.98
Total for Department: 481 SEWER SYSTEM				53,030.94
Department: 482 DISPOSAL PLANT				
78313	CENTURYLINK	PHONE SERVICE	10/07/2016	199.87
78324	BUNTING DISPOSAL, INC.	TRASH SERVICE	10/07/2016	40.09
78328	MAIL N COPY	MAILING OUT WATER SAMPLES	10/07/2016	14.03
78333	COLORADO ANALYTICAL LABORATORY	LAB TESTING	10/07/2016	239.00
78388	DENNIS MARKHAM	PER DIEM - VAIL COLORADO, ANNUAL OPER	10/11/2016	56.00
78400	USA BLUE BOOK	METER SUPPORT STAND	10/14/2016	167.30
78412	COLORADO ANALYTICAL LABORATORY	LAB TESTING	10/14/2016	43.00
78460	HACH ENVIRONMENTAL	LAB SUPPIES	10/21/2016	81.24
78461	MANWEILER HARDWARE, INC	PRUNERS AND SHEARS	10/21/2016	28.78
78464	CENTURYLINK	PHONE SERVICE	10/21/2016	61.73
78469	TIMBERLINE ELECTRIC AND CONTRO	HEAD WORKS PUMP CONTEROL REPAIR	10/21/2016	817.75
78470	USA BLUE BOOK	PLUG VALVES WITH HANDWHEEL	10/21/2016	2,436.90
78471	VARTEC TELECOM	FAX MACHINE	10/21/2016	1.27
78473	POUDRE VALLEY RURAL ELECTRIC ASSOCIATION	UTILITIES	10/21/2016	18,979.34
78474	BUNTING DISPOSAL, INC.	TRASH SERVICE	10/21/2016	40.00
78487	R.E. DAVIS CO	RENEWAL-ANNUAL BLOWER SERVICE PROG	10/21/2016	1,740.00
78506	CARD SERVICES	LODGING FOR CONFERENCE	10/21/2016	320.21
78555	JAX INC.	UNIFORMS	10/28/2016	75.96
78566	BATTERIES PLUS	BATTERY	10/28/2016	39.98
78573	SUBURBAN PROPANE	BULK TANK RENTAL	10/28/2016	67.00
78599	HELENA A. GERKIN	UNIFORMS	10/28/2016	188.42
Total for Department: 482 DISPOSAL PLANT				25,637.87
Total for Fund:07 SEWER FUND				83,096.33
Fund: 08 STORM DRAIN FUND				
Department: 000 NO PROJECT CODE				
78457	Leola Mackie	Refund Check	10/14/2016	22.50
78522	RICHMOND AMERICAN HOMES OF COLORADO, INC	BUILDING PERMIT REFUND	10/21/2016	644.11
78540	Bryon & Elaine Mc Avoy	Refund Check	10/21/2016	2.10
78543	Classic Custom Homes	Refund Check	10/21/2016	1.91
78545	Terry & Diane Wevers	Refund Check	10/21/2016	20.97
78546	Carpco, LLC	Refund Check	10/21/2016	35.05
78547	Michael & Janet Johnston	Refund Check	10/21/2016	6.06
78548	Landmark Partners, LLC	Refund Check	10/21/2016	2.72
78612	CENTURY COMMUNITIES, INC	BUILDING PERMIT REFUND - 8301 WYNSTON	10/28/2016	870.18
Total for Department: 000 NO PROJECT CODE				1,605.60
Department: 483 STORM DRAINAGE SYSTEM				
78305	COREN PRINTING, INC.	DELIN QUENT ENVELOPES	10/07/2016	75.66
78405	GLH CONSTRUCTION, INC.	LAW BASIN WEST TRIBUTARY CHANNEL	10/14/2016	37,072.54
78410	ANDERSON CONSULTING ENGINEERS	DRAINAGE MASTER PLAN UPDATE	10/14/2016	35,206.86
78427	PERRY LEWIS	REINBURSTMENT FOR UNIFORMS	10/14/2016	53.61
78520	WALSH CONSTRUCTION, INC	JOHN LAW PDM CONSTRUCTION	10/21/2016	294,488.41
78559	GLH CONSTRUCTION, INC.	LAW BASIN WEST TRIBUTARY CHANNEL - FI	10/28/2016	89,892.68
78584	BOMGAARS	HOSE, NOZZLE AND BATTERIES	10/28/2016	130.97
Total for Department: 483 STORM DRAINAGE SYS				456,920.73
Total for Fund:08 STORM DRAIN FUND				458,526.33

Check No.	Vendor/Employee	Transaction Description	Date	Amount
Fund: 10 FLEET MANAGEMENT FUND				
Department: 491 FLEET MANAGEMENT				
78314	4 RIVERS EQUIPMENT - AG, LLC	REPAIR REAR AXLE ON UNIT 100	10/07/2016	1,782.95
78330	WIRELESS ADVANCED COMMUNICATIO	LED LIGHT BULBS	10/07/2016	225.00
78332	O.J. WATSON EQUIPMENT	LIC. LIGHT BULB	10/07/2016	2.54
78337	MAC EQUIPMENT INC.	SERVICE REPAIR- T-1145	10/07/2016	246.35
78338	MYERS TIRE SUPPLY	TIRE SUPPLY	10/07/2016	35.83
78344	NAPA AUTO PARTS	WELDING SUPPLIES	10/07/2016	552.86
78345	BOBCAT OF THE ROCKIES LLC	TRANS, HYD. OIL & ANTIFREEZE FLUID	10/07/2016	518.88
78364	AGFINITY, INCORPORATED	FUEL FOR FLEET	10/07/2016	6,134.26
78397	SAFETY-KLEEN CORP.	PARTS WASHER SRVICE	10/14/2016	495.89
78408	KENZ AND LESLIE DISTRIBUTING	ADDITIVES FOR FLEET	10/14/2016	486.40
78446	WOYTASSEK WASHES, LLC	CAR WASH TOKENS	10/14/2016	184.10
78478	OFFICE DEPOT	COFFEE	10/21/2016	87.27
78480	WIRELESS ADVANCED COMMUNICATIO	LAP TOP MOUNT	10/21/2016	198.00
78503	SPRADLEY BARR FORD-GREELEY	REPAIR HARNESS DAMAGE	10/21/2016	387.00
78506	CARD SERVICES	FUEL FOR PARKS	10/21/2016	63.12
78517	DISCOVERY BENEFITS, INC	MSA ADMINISTRATION	10/21/2016	4.90
78521	CHRIS DEMPSEY	UNIFORM REIMBURSEMENT	10/21/2016	42.67
78556	J. J. KELLER AND ASSOCIATES	VEHICLE MAINTENANCE	10/28/2016	229.00
78561	OFFICE DEPOT	BATTERIES	10/28/2016	102.84
78571	REX OIL COMPANY	WASHER SOLVENT, OIL KITS, GLOVES	10/28/2016	370.72
Total for Department: 491 FLEET MANAGEMENT				12,150.58
Total for Fund:10 FLEET MANAGEMENT FUND				12,150.58
Fund: 11 INFORMATION TECHNOLOGY FUND				
Department: 492 INFORMATION TECHNOLOGY				
78306	VERIZON WIRELESS SERVICES LLC	CELL PHONE SERVICE	10/07/2016	212.76
78326	XEROX CORPORATION	LEASE PAYMENTS	10/07/2016	2,828.49
78341	CDW GOVERNMENT	XEROX IMAGING UNIT	10/07/2016	207.68
78343	COMCAST CABLE COMM. LLC	HIGH SPEED INTERNET - POLICE DEPT	10/07/2016	79.20
78383	OPEN MEDIA FOUNDATION	CHANNEL 8 LIVE STREAM & ON DEMAND SO	10/07/2016	3,000.00
78407	OFFICE DEPOT	OFFICE SUPPLIES	10/14/2016	10.91
78488	DELL MARKETING L.P.	TOUCH SCREEN MONITORS	10/21/2016	346.01
78491	COMCAST CABLE COMM. LLC	HIGH SPEED INTERNET - TOWN HALL	10/21/2016	214.90
78502	S CORPORATION INC	LASERFICHE ADDITIONAL LICENSES	10/21/2016	3,600.00
78506	CARD SERVICES	SSL CERTIFICATION	10/21/2016	2,248.94
78508	CARTEGRAPH SYSTEMS INC	OMS IMPLEMENTATION	10/21/2016	1,541.08
78515	QUILL CORPORATION	TONER, EXPO TOWELETTES	10/21/2016	806.79
78517	DISCOVERY BENEFITS, INC	MSA ADMINISTRATION	10/21/2016	4.90
78518	ACCELA, INC	UTILITY ONLINE BILLS - SEPTEMBER 2016	10/21/2016	2,554.00
78539	XCITE AUDIOVISUALS LLC	TOWN HALL AV UPGRADE	10/21/2016	125,853.03
78569	COMCAST CABLE COMM. LLC	INTERNET - POLICE DEPT	10/28/2016	24.53
78589	APPLIED GEOLOGICS INC	CEMETERY SOFTWARE ANNUAL MAINTENAI	10/28/2016	1,730.00
78592	QUILL CORPORATION	RECHARGEABLE BATTERIES	10/28/2016	546.76
Total for Department: 492 INFORMATION TECHNO				145,809.98
Total for Fund:11 INFORMATION TECHNOLOGY				145,809.98

Check No.	Vendor/Employee	Transaction Description	Date	Amount
Fund: 15 HEALTH INSURANCE FUND				
Department: 000 NO PROJECT CODE				
78361	1ST BANK OF NORTHERN COLORADO	EMPLOYEE BENEFITS FUNDING	10/07/2016	10,206.19
78505	1ST BANK OF NORTHERN COLORADO	EMPLOYEE BENEFITS FUNDING	10/21/2016	10,218.31
Total for Department: 000 NO PROJECT CODE				20,424.50
Total for Fund: 15 HEALTH INSURANCE FUND				20,424.50
Fund: 17 FACILITY SERVICES				
Department: 496 CUSTODIAL SERVICE				
78315	CIRSA	WC CLAIMS	10/07/2016	-0.01
78317	SUPPLYWORKS	SPOT KIT	10/07/2016	178.02
78357	FISH WINDOW CLEANING	WINDOW CLEANING @ PD	10/07/2016	415.00
78399	SUPPLYWORKS	CLEANING SUPPLIES	10/14/2016	487.17
78407	OFFICE DEPOT	OFFICE SUPPLIES	10/14/2016	10.91
78418	HILLYARD INC	ROLL TOWELS	10/14/2016	196.00
78467	CIRSA	WORKERS COMP	10/21/2016	409.62
78468	SUPPLYWORKS	CLEANING SUPPLIES	10/21/2016	219.32
78497	HILLYARD INC	ROLL TOWELS	10/21/2016	693.74
78516	VERITIV OPERATING COMPANY	CAN LINERS	10/21/2016	368.11
78553	SUPPLYWORKS	CLEANING SUPPLIES	10/28/2016	381.56
78594	VERITIV OPERATING COMPANY	CLEANING SOLUTION	10/28/2016	3,780.37
Total for Department: 496 CUSTODIAL SERVICE				7,139.81
Department: 497 FACILITY MAINTENANCE				
78308	GENERAL AIR SERVICE AND SUPPLY CO	CO-2	10/07/2016	114.08
78329	ENVIROPEST	PEST CONTRO @ PUMP STATION	10/07/2016	325.00
78339	CARRIER CORPORATION	AVAC REPAIRS @ CRC	10/07/2016	310.00
78354	SUMMIT SUPPLY CO INC	PLUMMING PARTS	10/07/2016	701.51
78362	GREELEY LOCK AND KEY	CHANGE KEY TO A MASTER SYSTEM	10/07/2016	309.49
78365	ROBERT L DOERKSEN	ALUMINUM - CRC	10/07/2016	178.50
78391	GENERAL AIR SERVICE AND SUPPLY CO	CO2	10/14/2016	14.21
78406	SCOTT'S ELECTRIC AND BUCKET TRUCK SERVICE INC	REPLACE MOTION DETECTOR WITH LIGHT S	10/14/2016	107.58
78407	OFFICE DEPOT	OFFICE SUPPLIES	10/14/2016	10.86
78411	HOME DEPOT	COVER	10/14/2016	55.79
78425	DEAN CONTRACTING, INC.	REPAIR CNATILEVER GATE	10/14/2016	1,095.00
78461	MANWEILER HARDWARE, INC	FLY STRIPS	10/21/2016	2.69
78464	CENTURYLINK	PHONE SERVICE	10/21/2016	50.55
78479	ENVIROPEST	PEST CONTROL-DIAMOND VALLEY	10/21/2016	268.00
78481	HOME DEPOT	CEILING TILE	10/21/2016	934.99
78482	DIV OF OIL AND PUBLIC SAFETY DEPT OF LABOR AND E	BOILER INSPECTION -POOL	10/21/2016	345.00
78486	CARRIER CORPORATION	SERVICE AGREEMENT RENEWAL	10/21/2016	1,237.50
78504	OLD NATIONAL BANK	ENERGY EFFICIENCY LEASE PURCHASE	10/21/2016	3,455.41
78619	BRAD C. SPINUZZI	POOL MAINTENANCE	10/28/2016	700.00
Total for Department: 497 FACILITY MAINTENAN				10,216.16
Total for Fund: 17 FACILITY SERVICES				17,355.97
Fund: 19 DOWNTOWN DEVELOPMENT				
Department: 486 DOWNTOWN DEVELOPMENT				
78350	PITNEY BOWES	POSTAL LEASE	10/07/2016	12.09
78351	ROBERT WINTER	FOOD FOR DDA APPRECIATION BBQ	10/07/2016	255.46
78376	AYRES ASSOCIATES, INC.	PROFESSIONAL SERVICES THROUGH SEPTEN	10/07/2016	4,811.50
78506	CARD SERVICES	CONSTANT CONTACT - SEPT	10/21/2016	20.00
78523	LILEY LAW OFFICES, LLC	DDA LEGAL SERVICES SEPTEMBER 2016	10/21/2016	4,928.00
78597	KAILLEE MELENDEZ	WEBSITE UPDATE, NEWSLETTER, EMAIL FOF	10/28/2016	137.50
Total for Department: 486 DOWNTOWN DEVELOP				10,164.55
Total for Fund: 19 DOWNTOWN DEVELOPMENT A				10,164.55

Check No.	Vendor/Employee	Transaction Description	Date	Amount
Fund: 21 COMMUNITY CENTER EXPANSION				
Department: 000 NO PROJECT CODE				
78522	RICHMOND AMERICAN HOMES OF COLORADO, INC	BUILDING PERMIT REFUND	10/21/2016	1,211.80
78606	JENNIFER THOMPSON	REFUND MV SLAES TAX -LARIMER CTY	10/28/2016	3.75
78612	CENTURY COMMUNITIES, INC	BUILDING PERMIT REFUND - 8301 WYNSTON	10/28/2016	1,253.33
Total for Department: 000 NO PROJECT CODE				2,468.88
Department: 493				
78308	GENERAL AIR SERVICE AND SUPPLY CO	START UP CHEMICALS - POOL	10/07/2016	245.55
78327	OFFICE DEPOT	OFFICE SUPPLIES	10/07/2016	437.61
78337	MAC EQUIPMENT INC.	MOWER	10/07/2016	1,519.00
78353	GEORGE R. MAROLT	BENCHES FOR CRC EXPANSION	10/07/2016	2,195.00
78368	VERITIV OPERATING COMPANY	FLOOR SCRUBBER & START UP SUPPLIES	10/07/2016	5,206.27
78373	PINKARD CONSTRUCTION COMPANY	CRC EXPANSION	10/07/2016	1,419,888.62
78387	AMERICAN FLOOR MATS	CRC EXPANSION RUGS	10/07/2016	2,968.88
78413	MANWEILER APPLIANCE	APPLICATIONS FOR CRC EXPANSION	10/14/2016	4,121.00
78423	CONSORT DISPLAY GROUP	DESIGN & SETUP FEE FOR NEW BANNER	10/14/2016	493.93
78435	MITY-LITE INC	PARTY ROOM TABLE / CHAIRS	10/14/2016	4,502.53
78436	WELD COUNTY PUBLIC HEALTH & ENVIRONMENT	POOL / SPA INSEPCION PROGRAM	10/14/2016	280.00
78438	BARKER RINKER SEACAT ARCHITECT	CRC EXPANSION	10/14/2016	9,815.28
78440	AWARD ALLIANCE LLC	CRC DEDICATION PLAQUE	10/14/2016	1,225.00
78444	UNITED VOLLEYBALL SUPPLY, LLC	VOLLEYBALL NET FOR AUX GYM	10/14/2016	279.03
78445	4IMPRINT, INC	GRAND OPENING	10/14/2016	10,134.42
78455	COMMERCIAL FITNESS SOLUTIONS, INC	WEIGHT ROOM EQUIPMENT	10/14/2016	143,148.50
78506	CARD SERVICES	CRC GRAND OPENING SUPPLIES	10/21/2016	20,144.64
78512	HAYNEEDLE, INC	CRC EXPANSION SUPPLIES	10/21/2016	20,432.26
78528	SIGNS NOW	TOT LOT DEDICATION PLAQUE	10/21/2016	364.67
78536	SPRINT AQUATICS	CRC EXPANSION SUPPLIES	10/21/2016	805.90
78537	SWIMOUTLET.COM	CRC EXPANSION SUPPLIES	10/21/2016	3,363.22
78538	LIFEGUARD STORE, INC	CRC EXPANSION SUPPLIES	10/21/2016	4,233.24
78560	BUNTING DISPOSAL, INC.	ROLL OFF - CRC EXPANSION	10/28/2016	400.00
78562	WHOLESALE DISTRIBUTION ALLIANCE LTD	CRC EXPANSION - PRO SHOP PRODUCTS	10/28/2016	2,436.66
78563	DOMINOS PIZZA	CRC GRAND OPENING FRIENDS & FAMILY NI	10/28/2016	543.68
78567	VERMONT SYSTEMS, INC.	GIFT CARDS	10/28/2016	770.75
78568	CTL/THOMPSON, INC.	CRC EXPANSION TESTING CONTRACT	10/28/2016	350.00
78569	COMCAST CABLE COMM. LLC	INTERNET - CRC	10/28/2016	271.10
78587	BARKER RINKER SEACAT ARCHITECT	CRC EXPANSION	10/28/2016	16,855.07
78593	SECURITY AND SOUND DESIGN	FIRE WIRE	10/28/2016	617.94
78594	VERITIV OPERATING COMPANY	VACUUM PRO TEAM SUPER COACH	10/28/2016	2,365.09
78608	SIGNS NOW	RULE SIGNS	10/28/2016	8,561.21
78617	CHELSEA ELLINGSON	GRAND OPENING PHOTOGRAPHY	10/28/2016	500.00
78618	WALKER LANDSCAPING INC	CRC LANDSCAPING	10/28/2016	13,729.00
Total for Department: 493				1,703,205.05
Total for Fund:21 COMMUNITY CENTER EXPANS				<u>1,705,673.93</u>
Accounts Payable Total				4,323,367.90
Payroll total = 2 pay periods				423,909.10
Grand Total				<u><u>\$4,747,247.00</u></u>



MEMORANDUM

Date: November 14, 2016
To: Mayor and Town Board
Via: Regular meeting materials, November 14, 2016
From: Ian D. McCargar, Town Attorney
Re: Amendment to Front Range Energy water lease
Item #: C.1.

Background / Discussion:

As an economic inducement to bring the first industrial user to the Great Western Industrial Park ("GWIP"), the Town agreed to provide augmentation water to Front Range Energy ("FRE") under a Water Lease ("Lease"). The Town and FRE have negotiated a modification of the Water Lease, which is presented this evening for Town Board approval.

Original Lease: The attached Water Lease (March 28, 2005) is between the Town of Windsor and FRE. The term of the Lease is 99 years. FRE agreed to pay the Town a total of \$2M, consisting of an up-front payment of \$400,000, with the remaining \$1.6M payable in equal installments over the first ten years of the Lease term. The Lease guaranteed FRE up to 500 acre-feet per year, for augmentation of various water wells located on the FRE property in GWIP. The well water was to be used only on the FRE site in support of its ethanol production operations.

Changed circumstances:

1. **Water Court Decree.** After the FRE Lease was signed, the Water Court approved the Decree in the Town's 2002 Change of Use case. The Court made a determination of how much augmentation water is available to the Town in Kern Reservoir (Windsor Lake). Although we argued for a higher figure, we ultimately settled on a lesser number with the objectors. As a result, the Town's commitments for its augmentation requirements, plus the potential for up to 500 AF to FRE under the Lease, left very little room to preserve lake levels and meet the expectations of our operating agreement with New Cache.
2. **FRE Actual Usage.** Despite having up to 500 AF available under our Lease, FRE has never needed anywhere near that much. Although FRE has suggested it might someday need the full 500 AF, history tells us otherwise.

Negotiations: Since 2012, we have been negotiating terms under which FRE would accept a modification to the 500 AF figure, understanding that FRE would receive a credit or reimbursement for the reduced amount of water under discussion. We settled on a new maximum of 435 AF. In addition, FRE wanted to use the augmentation water

to offset well depletions from water sales to third parties. We ultimately settled on a limitation requiring that any augmentation water would offset well depletions, so long as the end use of the well depletions takes place inside the Town's corporate limits.

Results: The attached Amendment to Water Lease contains these modifications to the original Lease:

1. Reduces the guaranteed maximum of annual augmentation water from 500 AF to 435 AF. The remaining 65 AF is now the Town's, free of any commitments to FRE.
2. Gives FRE a credit of \$260,000, which is the agreed value of the 65 AF being returned to the Town. The credit is being realized through a waiver of the final (2016) installment payment, plus a \$100,000 cash payment due after January 1, 2017. This sum is budgeted for 2017.
3. Restricts the use of Town augmentation water to FRE well depletions used in any location in Windsor. This term keeps the benefits of our inducement to FRE, but spreads it beyond FRE's property. In effect, FRE's well depletions cannot be augmented by Town water for FRE water sales to third parties who use the water outside of the Town.
4. Allows the Town to use any source of legally-available water to satisfy the Lease requirements.

FRE's representative has signed the attached Amendment.

Financial Impact:

	Budget	Proposed	Note
Revenue	\$160,000	\$0.00	Waive 2016 payment
Expense	\$0	\$100,000	2017 Budget
Net	<\$160,000>	<\$260,000>	Total credit and cash to FRE

Relationship to Strategic Plan: Prosperous local economy

Recommendation: Approve Resolution Approving an Amendment to Water Lease between the Town of Windsor, Colorado, and Front Range Energy, LLC. Simple majority required.

Attachments:

March 28, 2005, Water Lease;

November 7, 2016, Amendment to Water Lease;

Resolution Approving an Amendment to Water Lease between the Town of Windsor, Colorado, and Front Range Energy, LLC

TOWN OF WINDSOR

RESOLUTION NO. 2016-75

A RESOLUTION AN AMENDMENT TO A WATER LEASE BETWEEN THE TOWN OF WINDSOR AND FRONT RANGE ENERGY, LLC

WHEREAS, the Town of Windsor (“Town”) is a Colorado home rule municipality with all powers and authority provided by Colorado law; and

WHEREAS, as an inducement for the location of the Front Range Energy ethanol production facility in the Great Western Industrial Park, the Town and Front Range Energy, LLC, entered into a Water Lease dated March 28, 2005; and

WHEREAS, the parties to the Water Lease have negotiated certain modifications to its terms, while preserving the essential purpose of economic development and sound water planning; and

WHEREAS, the Town Board has reviewed the attached Amendment to Water Lease dated November 7, 2016, the terms of which are incorporated herein by this reference as if set forth fully; and

WHEREAS, the Town Board has concluded that the attached Amendment to Water Lease promotes the public health, safety and welfare; and

WHEREAS, the Town Board wishes to approve the attached Amendment to Water Lease, and authorize the Mayor to execute it on the Town’s behalf.

NOW, THEREFORE, BE IT RESOLVED BY THE TOWN BOARD OF THE TOWN OF WINDSOR, COLORADO, AS FOLLOWS:

1. The attached Amendment to Water Lease dated November 7, 2016, is hereby approved.
2. The Mayor is hereby authorized to execute the Amendment to Water Lease on the Town’s behalf.

Upon motion duly made, seconded and carried, the foregoing Resolution was adopted this 14th day of November, 2016.

TOWN OF WINDSOR, COLORADO

By: _____
Kristie Melendez, Mayor

ATTEST:

Patti Garcia, Town Clerk

AMENDMENT TO WATER LEASE

This **Amendment to Water Lease** ("Amendment") is entered into this 7 day of November, 2016, by and between **Front Range Energy, LLC** ("FRE"), an Oregon limited liability company authorized to transact business and own property in the State of Colorado, and the **Town of Windsor**, a Colorado home rule municipal corporation ("Windsor"), jointly referred to herein as the "Parties."

Recitals

A. FRE, as lessee, and Windsor, as lessor, entered into a Water Lease dated March 28, 2005, recorded in the Weld County real property records on October 31, 2005, at Reception No. 3336150 ("**Water Lease**").

B. Under the Water Lease, Windsor agreed to lease to FRE "year-round augmentation water . . . in an amount of 500 acre-feet annually (the '**Leased Water**')." The Water Lease also contained certain other terms and conditions regarding the place of use of the Leased Water and related matters.

C. The Parties acknowledge that FRE has paid all but One-hundred Sixty-thousand Dollars (\$160,000.00) of the Rental Payment required under Section 8 of the Water Lease.

D. FRE and Windsor now wish to amend the Water Lease to reduce the amount of Leased Water that Windsor is obligated to provide annually, adjust the payment provisions of the Lease to reflect that reduction, clarify and expand the place of use provisions, and address related matters to resolve all currently outstanding issues regarding the Water Lease.

Agreement and Lease Amendment

NOW, THEREFORE, in consideration of the mutual covenants and agreements set forth below, and for other good and valuable consideration, the receipt and adequacy of which is hereby acknowledged by both Parties, the Parties agree as follows:

1. Recitals and Defined Terms. The above Recitals are considered to be a part of this Amendment. Terms defined and capitalized in the original Water Lease and used herein shall have the same meaning as defined in the original Water Lease, unless and except as expressly revised in this Amendment.

2. Reduction of Amount of Leased Water. The Parties agree that Section 2 of the Water Lease shall be amended by the substitution of "435 acre-feet" for "500 acre-feet".

3. Amendment of Payment Provisions. The rental payment, refund formulas, and Kern Reservoir and Ditch Company assessment provisions in Paragraphs 2, 8, 9 and 12 of the original Water Lease are hereby reduced and adjusted in proportion to the reduction of the amount of Leased Water from 500 acre-feet to 435 acre-feet annually (i.e., each is reduced by 13%). Specifically, under Paragraph 8 of the original Water Lease, the total rental payment

owed by FRE is reduced from \$2,000,000.00 (by \$260,000.00) to a new adjusted total of \$1,740,000.00. To date, FRE has already paid to Windsor \$1,840,000, so Windsor shall reimburse and pay to FRE the sum of \$100,000 on or before ten (10) days after the Effective Date of this Amendment or January 6, 2017, whichever is later.

4. Adjusted Place of Use Restrictions. Notwithstanding any provisions of the original Water Lease to the contrary, FRE is authorized to use the Leased Water, directly or by contract with a third party, and in whole or in part, for augmentation of any water use within the water service area of Windsor, including but not limited to use in connection with FRE's ethanol plant on its Property. For uses authorized by this provision, both the water delivery and end-use must be within Windsor's service area. No uses by FRE shall require Windsor to deliver water other than to the Cache la Poudre River at the point where the Kern lateral discharges to said River in Section 34, Township 6 North Range 67 West in the 6th P.M. at a point 2,890 feet from the North Section Line and 3,140 feet from the East Section Line. Notwithstanding any provisions of the original Water Lease to the contrary, any such use outside of FRE's Property but otherwise within Windsor's service area as described herein will not in itself be grounds for termination of this Amended Water Lease.

5. Water Rights to be Used as Augmentation Water. Windsor currently owns all 100 shares of stock in the Kern Reservoir and Ditch Company. The senior water right owned by the Kern Reservoir and Ditch Company was changed to authorize use for augmentation in Case No. 02CW301. Kern Reservoir and Ditch Company also owns other water rights including, but not necessarily limited to, a junior storage right decreed in Case No. 02CW276, 8 shares of stock in the New Cache la Poudre Irrigating Company, and the Clammer and Gregory Ditch, as decreed in Case No. 86CW46. As provided in Paragraphs 9 and 11 of the original Water Lease, Windsor owns sufficient water that is fully decreed and usable for augmentation purposes represented by its shares of stock in the Kern Reservoir and Ditch Company to satisfy its obligations under the Water Lease, as amended by this Amendment ("**Amended Water Lease**"), and "Windsor shall under all circumstances make available to FRE on a first use and priority basis all of the water that is available to Windsor by virtue of its ownership of shares of stock in Kern Reservoir and Ditch Company, for purposes of meeting the augmentation requirements of FRE and any related operations on the Property at a particular time." In addition, Windsor owns and may in the future acquire other water rights which may be used for augmentation. To the extent authorized under the augmentation plan ultimately decreed for FRE's Wells in Case No. 05CW226, Water Division 1, Windsor may, at its option, substitute and deliver water derived from any of the water rights it owns or otherwise has the right to use in order to satisfy its obligations under this Amended Water Lease, so long as such rights are authorized by decree or a valid SWSP to be used for augmentation purposes, are allowed to be used under the Decree issued in Case No. 05CW226, are physically and legally available for such use at the time of delivery, are sufficient to allow FRE's Wells to operate pursuant to its decree as though water under the senior water right represented by Windsor's shares in Kern Reservoir had been delivered, and the water represented by said rights can and will be delivered to the Cache la Poudre River in Section 34, Township 6 North Range 67 West in the 6th P.M. at a point 2,890 feet from the North Section Line and 3,140 feet from the East Section Line, for use by FRE

consistent with this Amended Water Lease. FRE shall prosecute its application and seek a decree which authorizes use of water supplies to be supplied by Windsor consistent with this lease; however, FRE is under no obligation to amend the Decree ultimately entered in Case No. 05CW226 or to file any other notice, petition or pleading which may be required by that decree to add any future or currently unauthorized sources of augmentation water, unless such filings are subsequently agreed to by both Windsor and FRE.

6. Termination Due to Non-use or Dissolution. Notwithstanding any provision of the original Water Lease to the contrary, if FRE's Property is not used for manufacturing for five (5) consecutive years, or if FRE is dissolved voluntarily or involuntarily during the pendency of this Amended Water Lease, then Windsor shall notify FRE in writing and give FRE ninety (90) days to resume a manufacturing use on the Property. If such manufacturing use is not resumed within that time, the Amended Water Lease will be terminated, unless the Parties agree otherwise. Notwithstanding any provision of the original Water Lease to the contrary, if the Amended Water Lease is terminated for the above or for any other reason, then Windsor shall reimburse FRE for the proportionate amount of the total rental payment made by FRE under the Amended Water Lease, in accordance with the following formula:

$$\text{Years of remaining 99-year term} \times \$20,202.02 = \text{Reimbursement amount}$$

7. FRE Water Wells. The Wells serving FRE's ethanol plant on its Property and augmented by the Leased Water under the Amended Water Lease include all water wells described in and covered by the augmentation plan applied for and ultimately decreed in Case No. 05CW226.

8. Effective Date of Amendment. FRE's Wells are currently operating under Well Permits and a Substitute Water Supply Plan ("SWSP") approved by the State Engineer's Office ("SEO"), based on the substitute water supply provided under the Water Lease as it existed before this Amendment. In order to allow the FRE Wells to continue to operate without interruption, this Amendment shall not take effect until the SEO has issued new, replacement Well Permits for the Wells and the SEO has approved a new SWSP authorizing use of the Wells under the Amended Water Lease ("Effective Date"). Unless that date occurs on or before December 31, 2017, this Amendment shall not take effect and will be of no force and effect, unless the Parties agree in writing to extend that deadline.

9. Unrevised Terms Remain In Effect. Except as expressly revised in this Amendment, the terms and conditions of the original Water Lease remain as stated and in full force and effect.

FRONT RANGE ENERGY, LLC

By: 
Name: Dan Sanders
Title: Vice President

TOWN OF WINDSOR, COLORADO

By: _____
Kristie Melendez, Mayor

APPROVED AS TO LEGAL FORM:

Ian D. McCargar, Town Attorney

Brad Grasmick, Special Water Counsel

APPROVED AS TO CONTENT:

Kelly Arnold, Town Manager

STATE OF _____)

) ss.

COUNTY OF _____)

The foregoing instrument was acknowledged before me this _____ day of _____, 2016, by _____, in her capacity as Mayor of the Town of Windsor.

Witness my hand and official seal.

[Seal]

Notary Public
My commission Expires: _____

STATE OF Colorado)

) ss.

COUNTY OF Weld)

The foregoing instrument was acknowledged before me this 7th day of November, 2016, by Dan R. Sanders, in his capacity as Vice President of Front Range Energy, LLC.

Witness my hand and official seal.

[Seal]

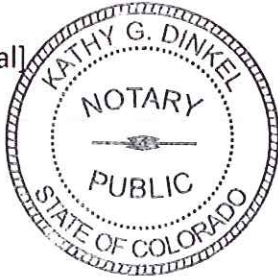

Kathy G. Dinkel
Notary Public
My commission Expires: 6-15-2018

821



3300821 07/07/2005 02:34P Weld County, CO
1 of 8 R 41.00 D 0.00 Steve Moreno Clerk & Recorder

7/11/05 301

WATER LEASE

150

This Water Lease ("Lease") is entered into effective this 28th day of March, 2005, by and between Front Range Energy, LLC ("FRE"), an Oregon limited liability company authorized to transact business and own property in the State of Colorado, and the Town of Windsor, a Colorado home rule municipal corporation ("Windsor").

Recitals

A. Windsor owns sufficient shares of stock in the Kern Reservoir and Ditch Company to lease 500 acre-feet of water annually to FRE.

B. FRE is in the process of constructing an ethanol plant to be located on the parcel described in Exhibit A (hereinafter the "Property"), which exhibit is attached hereto and incorporated herein by this reference. FRE intends to supply the commercial/industrial water requirements of the ethanol plant and irrigate the Property from a well or wells to be constructed by FRE on the Property (hereinafter "Wells").

C. FRE intends to obtain approval of an augmentation plan in District Court, Water Division 1, State of Colorado (hereinafter "Water Court") in order to legally operate the Wells out of priority. While FRE's augmentation plan application is pending, FRE intends to operate the Wells pursuant to a substitute water supply plan, or substitute water supply plans (hereinafter sometimes referred to as "SWSP(s)") if more than one is obtained, before final approval of FRE's augmentation plan decree, in accordance with section 37-92-308(4), C.R.S.

D. FRE wishes to enter into this Lease to assure itself that it will have a long-term source of water capable of serving as the augmentation supply in FRE's augmentation plan and SWSP(s), if FRE has not yet obtained final approval for its augmentation plan.

E. Windsor wishes to enter into this Lease to provide augmentation water to be used by FRE for its augmentation plan and, if necessary, FRE's SWSP(s).

Agreement and Lease

NOW, THEREFORE, for good and valuable consideration, the receipt and adequacy of which is hereby acknowledged, and in further consideration of the mutual covenants and agreements set forth below, the parties agree as follows:

1. Recitals. The Recitals are considered to be a part of this Lease.
2. Lease of Augmentation Water. Windsor agrees to lease to FRE year-round augmentation water (i.e., water delivered as described in paragraph 6 hereof under water rights that are owned by or available to Windsor and that are fully decreed and usable for the augmentation purposes described herein under Colorado water law) in an amount of 500 acre-feet annually (the "Leased Water"). It is agreed that all such water shall be used by FRE or its successors and assigns for purposes of augmenting the Wells on the Property for commercial, manufacturing and

3336150 10/31/2005 04:31P Weld County, CO
1 of 11 R 56.00 D 0.00 Steve Moreno Clerk & Recorder

industrial uses on the Property and for the irrigation of the Property or for any other commercial, industrial or irrigation use within Windsor's water service area, provided that the Leased Water shall not be used to augment or provide water to any residential development, and provided further that FRE will in good faith use the Leased Water to augment the Wells for use on the Property and to provide water service to FRE's Windsor ethanol plant and to the Property so long as it is economic to do so. It is also provided and agreed that before FRE shall use any Leased Water for purposes other than to augment the Wells for the provision of water service to FRE's Windsor ethanol plant or for other permissible uses on the Property, it shall notify Windsor in writing of such intent, of the entity or entities that are to use the water, the purpose or purposes of such use(s), the duration of time that such use will occur, and the amount of the Leased Water that is to be so used. If the use of the water is for five years or more from the date of the notice to Windsor, or if the right of use sought to be granted by FRE includes a right of extension or renewal without Windsor's consent for any period of time following an initial use of the water for a period of five years, or is an extension or renewal for any period of time following the right of use of the water for a five year consecutive period of time, then Windsor shall have 30 days following its receipt of such notice within which to notify FRE in writing of Windsor's intent to terminate this Water Lease as to such identified amount of water. If Windsor elects to terminate the Water Lease, it shall pay to FRE an amount of money, adjusted to the present value of money in the manner described in paragraph 12, and to be further determined as follows. First, the number of full years remaining on the 99 year lease will be determined. The amount of money to be paid will be a fraction of the total lease price of \$2,000,000, with that fraction having as its numerator the number of full years of FRE's remaining entitlement of use, and as its denominator the number 99. The number so obtained will be further adjusted based on the proportion of the amount of water stated in FRE's notice to the total amount of water leased, being 500 acre feet. The fraction to be used in such determination shall have as its numerator the amount of water stated in FRE's notice, and the denominator will be 500. Such money shall be paid by Windsor to FRE within 30 days of Windsor's notice to FRE of its intent to terminate the water lease as to the amount of water stated in FRE's notice. Windsor may elect to terminate the lease only as to all of the water amount stated in the FRE notice. If, at the time Windsor elects to terminate the water lease as provided for herein, FRE owes Windsor all or a portion of the lease rental amount, then the amount that FRE owes Windsor shall be credited with the amount that Windsor may owe FRE, with such credited amount to be applicable to the next payment or payments owed by FRE to Windsor.

3. Term of Lease. The term of this lease shall be for a period of ninety-nine years.
4. Assignment of Lease Rights. Subject to the right of Windsor to terminate the lease as set forth in paragraph 2 above, the rights under this Lease and the Leased Water leased herein is assignable by FRE, or its successors, in whole or in part, provided that any such assigned rights and Leased Water may not be used for residential development as stated in Paragraph 2 above, and subject to the other limitations of use as stated in Paragraph 2 above. Windsor may assign its rights and obligations under this lease to another governmental or quasi-governmental entity, including to an Enterprise (as that term is defined in Article X, Section 20, of the Colorado Constitution) that Windsor may create, provided that such assignee has the capability of fully performing under this lease

agreement, and further provided that Windsor shall not be relieved of its obligations and responsibilities under this lease.

5. Discontinuation of Augmentation Water Uses. In the event that FRE or its successor(s) or assign(s) permanently discontinues the use of the Wells or the Leased Water or, upon notice by FRE or its successor(s) or assign(s), the Leased Water is no longer needed and being used to augment the depletions from the Wells or other authorized uses, this Lease shall terminate. If FRE or its successor(s) or assign(s) wish to permanently discontinue use of the Wells or use of the Leased Water for augmentation and thus wish to terminate the Lease under this provision, FRE or its successor(s) or assign(s) shall give to Windsor at least ninety (90) days' written notice prior to the effective date of termination. It shall be presumed that a failure by FRE or its successor(s) or assign(s) to request use of the Leased Water for augmentation or substitute water supply use for a period of five consecutive years is a permanent discontinuation of such uses, provided that an annual or average use below the volume stated herein will not trigger such presumption or reduce the annual allotment to FRE. If Windsor believes that there has been no use or requested use of the Leased Water for augmentation for five consecutive years so as to trigger the above presumption of termination, it shall provide written notice to FRE or its successor(s) or assign(s) at least ninety (90) days prior to the proposed date of termination of the lease. FRE or its successor(s) or assign(s) may prevent termination of the lease by responding to Windsor in writing (1) that it wishes immediately to continue or resume use of the Leased Water for augmentation and does in fact resume use of all or some of the Leased Water within ninety (90) days or (2) demonstrating that the Leased Water has been used for augmentation within the preceding five-year period.
6. Delivery of Augmentation Water. Windsor shall make deliveries of the Leased Water to FRE upon FRE's schedule. Delivery schedules shall be provided on an annual basis at least 10 (ten) days prior to June 1 of each year. Minor modifications to such schedule can be made during the ensuing year, if acceptable to both parties. Delivery rates by Windsor shall be at the average rate of one (1) cubic foot per second or such other flow rate, not to exceed two (2) cubic feet per second, that will provide the full annual supply of 500 acre feet per year and will comply with the requirements of FRE's plan for augmentation or substitute supply plan. It is anticipated that the water will be measured at a meter to be inserted into the pipeline that will deliver water from the Kern Reservoir to the Cache La Poudre River, but the delivery path may change in the future, and Windsor shall have the right to measure the water at some other point between the Kern Reservoir and the Cache La Poudre River, to the extent such change in the measurement point is authorized under FRE's approved augmentation plan or temporary substitute supply plan, as it may be amended to allow such change, if necessary, at the sole cost of Windsor. FRE agrees to seek, in any application it may make for a plan for augmentation or substitute water supply plan, to have the decree or plan approval that is being sought allow for Windsor to have the right to change its delivery path and measurement location, as referred to above. The delivery point to the Cache La Poudre River will be at the end of the Town of Windsor's storm water outfall at the approximate center point of Section 34, Township 6 North, Range 67 West of the 6th P.M., Weld County, Colorado.
7. FRE's Augmentation Plan. Windsor shall not contest FRE's inclusion and use of the Leased Water in its substitute supply plan application or its Water Court augmentation

plan application; however, Windsor may file a "statement of opposition" to FRE's application and may otherwise participate in legal and administrative proceedings concerning FRE's Water Court or supply plan applications to prevent entry of a decree or approval of a supply plan with any finding of fact, conclusion of law, order, judgment, approval, determination or decree which adversely affects Windsor's water rights. Windsor shall cooperate with and provide reasonable assistance and information to FRE to aid FRE in obtaining State Engineer's Office approval of a substitute supply plan and a decreed augmentation plan from the Water Court, including executing and assisting FRE in seeking to obtain any "dry-up" covenants or other instruments required to use the Leased Water to augment the Wells or for other authorized uses. If it should become necessary for Windsor to seek to have the plan for augmentation or substitute water supply plan modified, as is addressed in paragraph 6, FRE agrees to cooperate with and to provide reasonable assistance to Windsor in its efforts.

8. Rental Payment. In full consideration for all rights and interests granted, costs incurred, and services rendered or to be rendered or performed by Windsor hereunder, FRE shall pay to Windsor a total, up-front rental payment of \$4,000.00 (Four Thousand Dollars) per acre-foot for 500 acre-feet of Leased Water per year for the duration of the Lease, with \$400,000 being payable not later than ten (10) days following the beginning of production of ethanol or other product from the plant to be constructed on the Property. FRE shall provide Windsor with written notice of the date of start-up of production of the plant at least seven (7) days prior to start-up. If production has not begun by 365 days following the effective date of this Lease, then the initial \$400,000 payment shall be made on the 366th day following the effective date of the Lease. The remaining rental amount of \$1,600,000 shall be amortized into equal payments of \$160,000 per year over a ten (10) year period, and shall bear no interest. Each annual rental payment during that ten (10) year period shall be made on the same date as the submittal date of the initial \$400,000 rental payment, beginning one year thereafter. If any of the above rental payments is not made when due, such nonpayment shall be a default under this Lease, and Windsor shall be entitled to terminate this Lease, unless such default is cured under Paragraph 13 below. Such rental amount shall include payment for the storage by Windsor of the Augmentation Water in Kern Reservoir, also known as Windsor Lake, or such other storage location(s) as may be available to Windsor. If this Lease shall terminate or be terminated for any reason, other than due to breach of the Lease by Windsor, all rental payments theretofore received by Windsor may be retained by Windsor, but no further payments by FRE or its owners will be required. Notwithstanding any other provision herein, if the Leased Water is not approved by the Water Court for use to augment the Wells in a permanent augmentation plan, Windsor shall return to FRE all sums paid under this Lease, minus a proportionate sum for each year, if any, that the leased water has been used in a temporary substitute supply plan. The parties recognize that the Leased Water will only be available for augmentation during the term of the Lease, and agree that any decreed augmentation plan that includes recognition of that fact and/or limits the augmentation of FRE's wells by the Leased Water only to such time as the Leased Water may be available to FRE shall still be considered to be a permanent plan. FRE will use reasonable efforts to present to the Water Court an application for a plan for augmentation that complies with legal requirements, and to prosecute the court case to successful completion.

3336150 10/31/2005 04:31P Weld County, CO
4 of 11 R 56.00 D 0.00 Steve Moreno Clerk & Recorder

3336150 10/31/2005 04:31P Weld County, CO
5 of 11 R 56.00 D 0.00 Steve Moreno Clerk & Recorder

9. Water Delivery Obligation. Windsor represents that under reasonable and foreseeable circumstances it should have adequate, fully-consumable water to deliver to FRE under this lease. However, Windsor's water supplies, including that provided by virtue of its ownership of Kern Reservoir and Ditch Company shares, are dependent upon natural water resources that vary in quantity from year to year, and which can be affected by conditions beyond Windsor's control. Therefore, Windsor shall not be liable for an actual failure of its water supply due to natural conditions, or due to other causes beyond Windsor's reasonable control. In times of such shortage or failure, Windsor may curtail or discontinue the amount of water provided under this Lease, provided that Windsor shall under any circumstances make available to FRE on a first use and priority basis all of the water that is available to Windsor by virtue of its ownership of shares of stock in Kern Reservoir and Ditch Company, for purposes of meeting the augmentation requirements of FRE and any related operations on the Property at a particular time, and Windsor otherwise shall also make every reasonable effort to create a water supply for the plant to prevent curtailment of FRE operations and those dependent upon this augmentation Lease. In the event of such curtailment or discontinuance, Windsor shall refund to FRE or its successor(s) or assign(s) the applicable pro rata lease payment amount and shall make reasonable attempts to notify FRE in advance of any interruption of delivery. Two examples of how a refund of a prorata lease payment amount would operate follow. If during a particular year Windsor was able to only deliver 400 acre feet of water, then 100 acre feet, or 20% of what is required by the Water Lease, would be undelivered. Windsor would be required to refund 20% of the annual rental amount. The annual rental amount is \$2,000,000 divided by 99 years, or \$20,202.02. Twenty percent of the annual rental would be \$4,040.02. As a second example, if Windsor could only deliver 499 acre feet in a year, then Windsor would refund \$40.40, being the annual rental for one acre foot of water.

10. Notices. Any notices required hereunder shall be in writing and shall be sent by certified mail, commercial over-night courier, or hand-delivery to the parties at the following addresses, unless a party notifies the other party in writing that such contact or address has changed:

For the Town of Windsor:

Town Manager
Town of Windsor
310 Walnut Street
Windsor, CO 80550

For Front Range Energy, LLC:

Front Range Energy, LLC
6867 S.E. Hogan Road
Gresham, OR 97080
Attn: Dan Sanders

11. Water Rights to be Used as Augmentation Water. Windsor intends to use water provided by virtue of its ownership of shares of stock in the Kern Reservoir and Ditch Company,

which operates the Kern Reservoir, also known as Windsor Lake, to satisfy its obligations under this Lease, to the extent that such water is usable as augmentation water or water that is useable in a substitute water supply plan. The water rights available from Kern Reservoir and subject to this Lease are described in Exhibit B attached hereto.

12. Kern Reservoir and Ditch Company Assessments. Any expense to maintain, improve or repair the Kern Reservoir storage facility and associated ditches and other structures shall not be charged to or borne by FRE or its affiliates at any time before or during the first 10 years after start-up of FRE's ethanol plant. After this 10 year period, it is anticipated that the Kern Reservoir and Ditch Company (the "Reservoir Company"), the owner of the Kern Reservoir, may, during the remaining period of this Lease, effectuate repairs, maintenance (to include dredging) and renovations to the Reservoir that will require it to assess its shareholders, including Windsor, greater amounts than would normally be assessed for routine and normal reservoir operations. Such increased amounts could be raised by the Reservoir Company making a special assessment(s) for the funds needed, or by annual assessments markedly greater than normal annual assessment amounts. For purposes of this Lease, it shall be conclusively presumed that an annual assessment, or an annual assessment plus a special assessment during the same calendar year, that is more than 150% greater than the average annual assessment for the preceding ten year period is an "extraordinary annual assessment". FRE agrees to reimburse to Windsor a portion of the increase of an extraordinary annual assessment over and above the average annual assessment for the preceding 10 years, within 90 days of receiving proof from Windsor of its paying such extraordinary annual assessment. The portion to be paid by FRE to Windsor shall be equal to 500/2250 (which is 1 / 4.5 or 22.2%) of the above-described increase in the extraordinary annual assessment. This ratio is based on Windsor's owning approximately 2,250 acre-feet of the storage capacity of the Kern Reservoir by virtue of its share ownership, of which 500 acre-feet are to be leased to FRE. Any assessment pertaining to FRE will only be for that portion of the Reservoir Company assessment which applies to the 500 acre feet that comprises the Leased Water. and not for any expenses affiliated with Windsor operations or recreational needs or additional Windsor customers or other Reservoir Company shareholders. It shall be conclusively presumed that any special assessment made for the purpose of enhancing and/or protecting the pro-rata water yields of all Reservoir Company shares shall apply to the 500 acre feet of Leased Water. Notwithstanding any other provision herein, under any circumstances, the obligation of FRE or its successors under this provision shall be no more than \$100,000 in any single calendar year and no more than a total of \$200,000 in any seven-year period, as adjusted over time by the Denver-Boulder Consumer Price Index, with the beginning year for determining any adjustments being 2005. Except as provided in this Paragraph 12, FRE and its successors shall not be liable or responsible in any respect for any costs, actions or inactions relating to Kern Reservoir or any other structure or facility owned, operated or used by Windsor or its agents in connection with this Lease.
13. Default. If either party shall fail or refuse to perform as required by the terms of this Lease, such party may be declared in default. Such declaration of default must be made in writing by the non-defaulting party. If a party has been declared in default of this Lease, such defaulting party shall be allowed a period of thirty (30) days after receipt of such notice within which to cure the default. If the default remains uncorrected, the party

3336150 10/31/2005 04:31P Weld County, CO
7 of 11 R 56.00 D 0.00 Steve Moreno Clerk & Recorder

declaring default may elect to: (1) terminate the Lease and seek damages; (2) treat the Lease as continuing and seek specific performance; and/or (3) pursue any other remedy available at law or equity. Notwithstanding any other provision of this Lease, Windsor's obligation to provide Augmentation Water to FRE or its successor(s) or assign(s) shall not be subject to the above 30-day right to cure.

- 14. Costs. In addition to the remedies available described in the preceding paragraph, if the default of any of the provisions of this Lease by either party require the non-defaulting party to commence legal action against the defaulting party, and the non-defaulting party prevails in such legal action or by commencing such action causes the defaulting party to cure the noticed default, then the defaulting party shall be liable to the non-defaulting party for the attorneys fees and other costs incurred because of the default.
- 15. Governing Law; Venue. This Lease shall be governed and enforced in accordance with the laws of the State of Colorado. Venue for any action regarding this Lease shall be in the District Court of Weld County, Colorado.
- 16. Recording. This Lease may be recorded by either party in the office of the Clerk and Recorder of Weld County, Colorado, and may be disclosed in Water Court proceeding(s) or SWSPs applications filed by FRE or its successor(s) or assign(s) to augment the permissible uses hereunder.
- 17. Counterparts. This Lease may be executed in counterparts, each of which (or a combination of which), when signed by both parties shall be deemed an original, but shall together constitute one agreement.
- 18. Headings. The underlined paragraph headings are for reference only, and are not to be considered as substantive parts of this lease.

IN WITNESS WHEREOF, the parties hereto have signed this Water Lease the day and year first written above.

TOWN OF WINDSOR, COLORADO

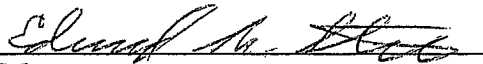
Mayor

ATTEST:

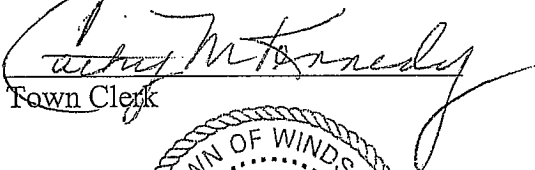
Town Clerk



FRONT RANGE ENERGY, LLC

Manager

STATE OF Oregon)
) ss.
COUNTY OF Multnomah)

The foregoing instrument was acknowledged before me this 26th day of March, 2005, by Sanders Daniel Alan in his/~~her~~ capacity as Manager of Front Range Energy, LLC.

Witness my hand and official seal.

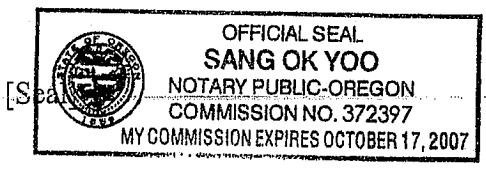
My commission expires: 10/17/07



Sang Ok Yoo
Notary Public



3300822 07/07/2005 02:34P Weld County, CO
7 of 16 R 81.00 D 0.00 Steve Moreno Clerk & Recorder

A TRACT OF LAND SITUATE IN SECTIONS 23, 26 AND 27, TOWNSHIP 6 NORTH, RANGE 67 WEST, OF THE 6TH P.M.; COUNTY OF WELD, STATE OF COLORADO; BEING MORE PARTICULARLY DESCRIBED AS FOLLOWS:

COMMENCING AT THE NORTHWEST CORNER OF SAID SECTION 27, AND CONSIDERING THE NORTH LINE OF THE NORTHWEST QUARTER OF SAID SECTION 27 TO BEAR N89°24'06"E, WITH ALL OTHER BEARINGS CONTAINED HEREIN RELATIVE THERETO; (SAID BEARING IS A GRID BEARING OF THE COLORADO STATE PLANE COORDINATE SYSTEM, NORTH ZONE, NORTH AMERICAN DATUM 1983 (1992), DETERMINED BY GEODETIC (GPS) OBSERVATIONS).

THENCE S76°56'29"E, 105.88 FEET TO A POINT ON THE EASTERLY RIGHT-OF-WAY LINE OF STATE HIGHWAY 257, SAID POINT ALSO BEING THE POINT OF BEGINNING;

THENCE ALONG A LINE PARALLEL TO AND 25.00 FEET SOUTH OF THE NORTH LINE OF SAID SECTION 27 (AS MEASURED BY RIGHT ANGLES) THE FOLLOWING TWO (2) COURSES;

- 1. N89°24'06"E, 2,505.04 FEET
- 2. N89°24'43"E, 2,606.54 FEET;

THENCE ALONG A LINE PARALLEL TO AND 25.00 FEET SOUTH OF THE NORTH LINE OF THE NORTHWEST QUARTER OF SAID SECTION 26 (AS MEASURED BY RIGHT ANGLES), N89°44'23"E, 2,519.71 FEET;

THENCE N00°34'19"W, 25.00 FEET TO A POINT ON THE NORTH LINE OF THE NORTHWEST QUARTER OF SAID SECTION 26;

THENCE N00°34'19"W, 30.00 FEET TO A POINT ON THE NORTHERLY RIGHT-OF-WAY LINE OF WELD COUNTY ROAD 66 (EASTMAN PARK DRIVE);

THENCE ALONG SAID NORTHERLY RIGHT-OF-WAY LINE, N89°44'23"E, 120.52 FEET;

THENCE CONTINUING ALONG SAID NORTHERLY RIGHT-OF-WAY LINE, N89°44'07"E, 1,320.15 FEET;

THENCE S00°02'54"E, 30.00 FEET TO THE EAST SIXTEENTH CORNER COMMON TO SECTIONS 26 AND 23;

THENCE ALONG THE EAST LINE OF THE WEST HALF OF THE NORTHEAST QUARTER OF SAID SECTION 26,

S00°02'54"E, 2,639.69 FEET TO A POINT ON THE NORTHERLY BOUNDARY OF LOT B OF RECORDED EXEMPTION NO. 0807-26-4-RE 455, SAID POINT ALSO BEING THE CENTER EAST SIXTEENTH CORNER OF SECTION 26;

THENCE ALONG THE NORTH BOUNDARY OF SAID LOT B, N89°41'50"E, 1,302.79 FEET TO A POINT ON THE WESTERLY RIGHT-OF-WAY LINE OF WELD COUNTY ROAD 23;

THENCE ALONG SAID RIGHT-OF-WAY LINE, S00°19'12"E, 33.57 FEET TO A POINT ON THE NORTH BOUNDARY OF LOT A OF RECORDED EXEMPTION NO. 0807-26-4-RE 455;

THENCE ALONG THE NORTH, WEST AND SOUTH BOUNDARY OF LOT A OF RECORDED EXEMPTION NO. 0807-26-4-RE 455, THE FOLLOWING THREE (3) COURSES:

- 1. S89°40'44"W, 274.79 FEET;
- 2. S01°22'02"W, 195.05 FEET;

3336150 10/31/2005 04:31P Weld County, CO
9 of 11 R 56.00 D 0.00 Steve Moreno Clerk & Recorder





3300822 07/07/2005 02:34P Weld County, CO
8 of 16 R 81.00 D 0.00 Steve Moreno Clerk & Recorder

3336150 10/31/2005 04:31P Weld County, CO
10 of 11 R 56.00 D 0.00 Steve Moreno Clerk & Recorder

3. N88°02'10"E, 280.65 FEET TO A POINT ON THE WESTERLY RIGHT-OF-WAY LINE OF WELD COUNTY ROAD 23;
 THENCE ALONG SAID WESTERLY RIGHT-OF-WAY LINE, S00°19'12"E, 1,098.82 FEET TO A POINT ON THE SOUTHERLY BOUNDARY OF LOT B OF RECORDED EXEMPTION NO. 0807-26-4-RE 455;
 THENCE ALONG THE SOUTH, WEST AND NORTH BOUNDARY OF SAID LOT B, THE FOLLOWING THREE (3) COURSES:
 1. S89°40'37"W, 2,603.15 FEET TO THE CENTER SOUTH SIXTEENTH CORNER OF SECTION 26
 BEING MARKED BY A 3" BRASS CAP WITH AN X, IN A CONCRETE POST;
 2. N00°25'32"W, 1,320.21 FEET TO THE CENTER QUARTER CORNER OF SECTION 26
 BEING MARKED BY A 3" BRASS CAP WITH AN X AND NO OTHER MARKINGS, IN A CONCRETE POST;
 3. N89°41'47"E, 1,237.79 FEET;
 THENCE N00°02'54"W, 2,574.73 FEET TO A POINT ON THE SOUTHERLY RIGHT-OF-WAY BOUNDARY OF WELD COUNTY ROAD 66 (EASTMAN PARK DRIVE),
 THENCE ALONG SAID RIGHT-OF-WAY LINE THE FOLLOWING FOUR (4) COURSES:
 1. S89°44'07"W, 1,255.17 FEET;
 2. S89°44'23"W, 2,639.33 FEET;
 3. S89°24'43"W, 2,606.54 FEET;
 4. S89°24'06"W, 2,557.30 FEET TO A POINT ON THE EASTERLY RIGHT-OF-WAY LINE OF STATE HIGHWAY 257;
 THENCE ALONG SAID RIGHT-OF-WAY LINE, N51°58'19"E, 65.81 FEET TO THE POINT OF BEGINNING.

SAID PARCEL CONTAINS 91.71 ACRES (3,994,612 SQUARE FEET) MORE OR LESS AND IS SUBJECT TO ALL RIGHTS-OF-WAY, EASEMENTS AND RESTRICTIONS OF RECORD OR THAT NOW EXIST ON THE GROUND.

EXHIBIT A
2 OF 2

**EXHIBIT B TO WATER LEASE
BETWEEN THE TOWN OF WINDSOR
AND
FRONT RANGE ENERGY
DATED MARCH 28, 2005**

The water rights available from Kern Reservoir, a/k/a Windsor Lake, and subject to the Water Lease are represented by 70 shares of stock owned by the Lessor, the Town of Windsor, in the Kern Reservoir and Ditch Company, a mutual ditch company. These 70 shares represent a 70% interest in the Company, which has 100 shares issued and outstanding. The Kern Reservoir and Ditch Company holds a decree for water rights issued by the District Court in and for the County of Larimer, State of Colorado, in Case No. 1591, being a general adjudication of rights to use water for reservoir purposes in Water District No. 3 of Water Division No. 1, State of Colorado. This right is for the storage of 1800 acre feet of water. The priority (by original construction) number assigned to the Kern Reservoir, a/k/a Windsor Lake, was No. 1, with the date of priority being stated as February 10, 1882. The decree states that about 1000 acres were irrigated from the reservoir.

The Kern Reservoir and Ditch Company also owns the rights to the Clammer and Gregory Ditch. This ditch was decreed in Case No. 86CW046, District Court, Water Division No. 1, State of Colorado, for 2 cfs of water, absolute, for the irrigation of approximately 226 acres of land. This right has a December 28, 1904, date of appropriation administered based on the 1986 year of filing of the application for the right. The decree was entered on December 12, 1988.

The Kern Reservoir and Ditch Company has filed an application in Case No. 2002CW301 to convert its shares from irrigation use to multiple uses, including municipal and augmentation uses. That case is presently pending in the District Court, Water Division No. 1.

The Kern Reservoir was recently enlarged. Therefore the Kern Reservoir and Ditch Company has also filed an application in the District Court, Water Division No. 1, Case No. 2002CW276, for an enlargement and refill right for the Kern Reservoir. The amount of 1966 acre feet is claimed, conditionally, for various uses, including municipal, commercial, industrial, augmentation and exchange. A right to fill and refill the reservoir when it may be in priority is also claimed. The claimed date of appropriation is March 1, 2002. The application was filed on November 25, 2002. This case is also presently pending before the court.

The Town of Windsor's pro rata interest in all of the above water rights, as the owner of 70 shares of stock in the Kern Reservoir and Ditch Company, is covered by and subject to the Water Lease.



MEMORANDUM

Date: November 14, 2016
To: Mayor and Town Board
Via: Kelly Arnold, Town Manager
From: Stacy Johnson, Director of Economic Development
Re: Kana Hotel Group – Incentive Request
Item #: C.2.

Background / Discussion:

On August 17, 2016 the Town Manager & Economic Development Director met with Martin Lind of Water Valley Land Company to discuss a proposed Hotel project at Eagle Crossing Windsor, east of the 7-11 at Crossroads and Fairgrounds Ave.

A company named Kana Hotel Group out of Knoxville, TN is interested in building a 3 hotel – two building hotel complex. The project has been divided into two phases to enable the developer to move quickly. In the first phase the hotel group is proposing to build a Spring Hill suites brand hotel, 4 stories high, with 96 rooms for a total building area of 57,150 sq. ft. The second phase will consist of two additional high end hotels 5 stories in height and contain approximately 206 rooms, a conference center for a total building area of 146,770 sq. ft.

These hotels are top of the line brands and would take a step towards fulfilling the development plan for the corridor. The area at Crossroads and Fairgrounds is an immature area of development and this project would be a huge momentum builder for this part of Windsor. Ideally this will begin to close the gap in our lack of product for sports tourism and conference meeting space and help to generate sales tax for the Town.

Below is an estimated project review:

Kana Hotel Group:

Cost (approx.)	\$30,000,000.00
Current Sales	\$12,000,000.00
Windsor Sales Tax (3.0%)	\$360,000.00
Windsor Sales Tax (.95%)	\$114,000.00
Hotels square footage	203,920
Employees	100 Direct Full time
Indirect jobs	30 Full Time
One time construction jobs	1,000
Total approximate annual impact	\$2,500,000

Financial Impact:

Both phases Fee Waivers:	\$673,873.14
½ 3% sales tax for 10 years	\$180,000 annually / \$1,800,000 10 years

Relationship to Strategic Plan:

Diversify, Grow & Strengthen the Local Retail and Industrial Economy

Attachments:

Resolution

Incentive agreement

Town Fee estimate

Exhibit A

Exhibit B (Cost analysis)

TOWN OF WINDSOR

RESOLUTION NO. 2016-76

A RESOLUTION APPROVING AN AGREEMENT FOR CERTAIN ECONOMIC INDUCEMENTS AND DEVELOPMENT INCENTIVES BETWEEN THE TOWN OF WINDSOR, COLORADO, AND WINDSOR HOTEL PARTNERS, LLC, WITH RESPECT TO THE DEVELOPMENT OF PROPERTY FOR COMMERCIAL PURPOSES WITHIN THE TOWN OF WINDSOR

WHEREAS, the Town of Windsor (“Town”) is a Colorado home rule municipality with all powers and authority provided by Colorado law; and

WHEREAS, municipal governments are legally authorized under Colorado law to encourage economic development; and

WHEREAS, the expansion and relocation of commercial enterprises, buildings and activity create a public benefit through increased employment, tax revenue and community reputation; and

WHEREAS, Windsor Hotel Partners, LLC, proposes to construct a hotel lodging complex in the Eagle Crossing Subdivision to house its lodging, convention and retail operations; and

WHEREAS, Windsor Hotel Partners, LLC, has presented the Town with data, upon which the Town is relying in concluding that the proposed hotel lodging facility will produce a public benefit sufficient to justify incentives and inducements for the proposed hotel lodging facility; and

WHEREAS, the Town and Windsor Hotel Partners, LLC, have negotiated the attached Agreement for Certain Economic Inducements and Development Incentives (“Incentive Agreement”), the terms of which are incorporated herein by this reference as if set forth fully; and

WHEREAS, the Town’s Director of Economic Development has recommended that the Town Board approve the Incentive Agreement; and

WHEREAS, the Town Board finds that approval of the Incentive Agreement will result in a public benefit sufficient to support the incentives contained therein.

NOW, THEREFORE, BE IT RESOLVED BY THE TOWN BOARD OF THE TOWN OF WINDSOR, COLORADO, AS FOLLOWS:

1. The attached Agreement for Certain Economic Inducements and Development Incentives between the Town of Windsor and Windsor Hotel Partners, LLC, is approved.
2. The Mayor is authorized to execute the Incentive Agreement on the Town's behalf.

Upon motion duly made, seconded and carried, the foregoing Resolution was adopted this 14th day of November, 2016.

TOWN OF WINDSOR, COLORADO

By: _____
Kristie Melendez, Mayor

ATTEST:

Patti Garcia, Town Clerk

**AGREEMENT
FOR
CERTAIN ECONOMIC INDUCEMENTS AND INCENTIVES**

THIS AGREEMENT FOR CERTAIN ECONOMIC INDUCEMENTS AND INCENTIVES (“Agreement”) is executed effective as of 14th day of November, 2016 (“Effective Date”), by and between the TOWN OF WINDSOR, COLORADO, a Colorado home rule municipal corporation (“Town”), and WINDSOR HOTEL PARTNERS, LLC, a Colorado limited liability company (“Developer”).

RECITALS:

- A. Developer is the owner of the real property located in Eagle Crossing Subdivision, Second Filing, legally-described as set forth in Exhibit A attached hereto and incorporated herein by this reference (“Property”). The Property is presently unimproved and is not connected to any water or sanitary sewer infrastructure.
- B. Developer intends to develop the Property in two (2) phases to be located upon the Property, consisting of:
 - 1. Phase 1, a hotel lodging complex consisting of between 96 and 100 rooms (“Phase 1 Facility”); and
 - 2. Phase 2, a two-structure hotel lodging complex with approximately 200 additional rooms (“Phase 2 Facility”).
- C. Construction of the Facilities will provide economic benefits to the Town, including but not limited to, increased tax revenue, employment and visitor attention.
- D. The Town desires to encourage Developer to develop the Property by offering certain inducements as set forth herein. Subject to the terms and conditions herein, Developer is requesting, and the Town desires to grant, certain economic inducements and incentives to facilitate the construction of the Facility.
- E. It is an appropriate and lawful function of Colorado municipalities to encourage economic vitality through economic inducements and incentives.

NOW, THEREFORE, in consideration of the mutual covenants and agreements set forth herein, and for other good and valuable consideration, the receipt and sufficiency of which are hereby acknowledged, the Town and Developer agree as follows:

- 1. The foregoing Recitals are fully incorporated herein by this reference with the same force and effect as though restated below.

2. Although it is anticipated that Developer will construct the Facilities, Developer shall have no obligation to construct either Facility. This Agreement does not create any obligation to construct either Facility at any time, under any circumstances whatsoever.
3. The Town's obligation to provide Developer with the economic inducements and incentive described below is conditioned upon Town Board approval of this Agreement and upon legal availability of funds. If each of these conditions is not satisfied, the Town shall have no obligation to provide inducements or incentives under this Agreement.
4. **Determination of Public Benefit, Reliance of the Town.**
 - a. The Town maintains certain guidelines for evaluating the public benefit of commercial development within its corporate limits, and the value of providing economic inducements and incentives to encourage and sustain such development. In reliance upon certain data and information provided to the Town by Developer and persons acting under Developer's direction, the Town has determined that construction and operation of the Facilities, and each of them, satisfies such guidelines and will be of substantial economic benefit to the Town.
 - b. The Town's determination of inducements and incentives primarily and substantially stems from its desire to encourage Developer to develop the Property through construction of each Facility. Developer and persons acting under Developer's direction have provided the Town with an estimate of the projected costs for the improvements to the Property, a copy of which is attached hereto and identified as Exhibit B. By entering into this Agreement, Developer intends and acknowledges that the Town is relying on these estimates in good faith.
 - c. Developer and persons acting under Developer's direction have provided the Town with certain information and representations upon which the Town has relied in determining future tax revenue generation from commercial activity anticipated to take place within each Facility. By entering into this Agreement, Developer intends and acknowledges that the Town is relying on these representations in good faith.

5. **Agreed Incentives and Inducements.**

In light of the foregoing and subject to the Incentive Cap set forth below, the Town agrees to the following incentives and inducements upon the terms and conditions set forth below:

- a. **Fee Waivers.** Subject to the Incentive Cap set forth below, the Town will forever waive the collection of certain building permit-related fees, the classification and estimated amounts for which are as follows:

	<u>Phase I</u>	<u>Phase II</u>
Windsor in-house Administrative Fee:	\$ 6,710.04	\$ 13,230.04
Windsor construction materials use tax:	<u>\$158,000.00</u>	<u>\$ 335,750.00</u>
TOTAL FEE WAIVER (Phases I & II)	\$513,690.08	

Phase 1 Fee Waivers shall be effective at the time the building permit for the Phase 1 Facility is issued. The Phase 2 Fee Waivers set forth above shall not take effect until such time as the Phase 2 Facility building permit is issued. In the event that the Phase 2 Facility building permit is not issued on or before January 1, 2020, the Phase 2 Fee Waivers in this sub-section shall be deemed permanently forfeited by the Developer.

- b. **Reimbursement of Other Building Permit-Related Fees.** In addition to the foregoing fee waivers and subject to the Incentive Cap below, the Town will reimburse the Developer for the following fees in the following order of priority:

	<u>Phase I</u>	<u>Phase II</u>
Safebuilt Building Fee:	\$15, 167.65	\$29,747.65
Safebuilt Electrical Fee	\$11,615.00	\$23,115.00
Safebuilt Plan Review Fee	\$ 9,858.97	\$19,335.97
Town Stormwater Drainage Fee	<u>\$17,780.94</u>	<u>\$33,561.88</u>
TOTAL FEE REIMBURSEMENT (Phases I & II)	\$160,183.06	

Phase 1 Fee Reimbursements under this sub-section (b) shall be payable within sixty (60) days of issuance of the certificate of occupancy for the Phase 1 Facility. The Phase 2 Fee Reimbursements set forth in this sub-section (b) shall not become payable until such time as the Phase 2 Facility certificate of occupancy is issued. In the event that the Phase 2 Facility certificate of occupancy is not issued on or before January 1, 2021, the Phase 2 Fee Reimbursements in this sub-section (b) shall be deemed permanently forfeited by the Developer.

Notwithstanding the aforementioned fee estimates, the total value of the Fee Waivers and Fee Reimbursements in the aggregate and the value of each such incentive and inducements contemplated under sub-paragraphs 5 (a) and (b) above SHALL NOT be final until the Town's issuance of the building permit for each Facility structure located on the Property in keeping with the Town's customary building permit fee practices. Accordingly, the total value of the incentives and inducements under sub-paragraphs 5 (a) and (b) above, and the value of each as contemplated herein, may increase or decrease (if at all), depending upon the final fees as stated in the building permits issued for each Facility structure located on the Property, as issued by the Town. In other words, the building permits as issued by the Town shall be determinative of the total value of the incentives and inducements under sub-paragraphs 5 (a) and (b) above in the aggregate, and the value of each, as contemplated herein.

6. **Sales Tax Share-back.** Subject to the terms and conditions set forth herein, the Town will reimburse a portion of sales tax collected from retail lodging sales taking place within each Facility ("Sales Tax Share-back").

- a. **Duration.** The duration of the Sales Tax Share-back shall not exceed ten (10) years from the date upon which retail lodging sales activity first commences within each Facility or any portion thereof. The Sales Tax Share-back shall terminate if the Sales Tax Incentive Cap is reached during the ten-year duration. Likewise, if the Sales Tax Incentive Cap has not been reached at the end of the ten-year duration of the Sales Tax Share-back, the Sales Tax Share-back shall nonetheless terminate. Upon termination as provided in this sub-paragraph, Developer waives, releases and disclaims any further claim to Sales Tax Share-back as provided in this Section 6.
 - b. **Percentage of Sales Tax Share-back, Eligible Sales Tax.** The Town will reimburse fifty percent (50%) of Eligible Sales Tax collected by the Town from retail lodging sales taking place within each Facility or any portion thereof. For purposes of this Agreement, Eligible Sales Tax shall be defined as an amount equal to the dollar amount of sales tax revenue generated by retail lodging sales activity within each Facility, less any previously set aside for construction and expansion of the Windsor Community Recreation Center under *Windsor Municipal Code* Section 4-2-20 (2) and 4-2-20 (9).
 - c. **Payee.** The Town shall pay the Sales Tax Share-back to each sales tax licensee remitting sales tax generated by retail lodging sales within each Facility in proportion to the sales tax actually paid by each such sales tax licensee.
 - d. **Timing and sequence.** Each sales tax licensee within each Facility shall collect, report and remit sales tax as required by applicable provisions of the *Windsor Municipal Code*. The Town shall tender payment of the Sales Tax Share-back once each calendar year on or before March 1, which payment shall capture each payee's share of the Eligible Sales Tax collected by Town during the previous calendar year.
 - e. **Receipt of Sales Tax Share-back, waiver of refunds and appeals.** Upon receipt of any reimbursement as provided in this Section 6, the recipient shall be deemed to have irrevocably waived any right to seek a refund or appeal the imposition of all sales tax available under both the *Windsor Municipal Code* and Colorado law.
7. **Incentive Cap.** In no event will the Town's aggregate fee waivers, reimbursements and Sales Tax Share-back exceed the sum of Two-Million-Five-Hundred-Fifty-Thousand Dollars (\$2,550,000.00) ("Incentive Cap"). The Incentive Cap will be allocated as follows for each category of incentive identified herein:
- a. The combined total of Fee Waivers, Fee Reimbursements and Improvement Costs Reimbursements described above shall not exceed Seven-Hundred-Fifty-Thousand Dollars (\$750,000.00)

- b. Sales Tax Share-back shall not exceed One-Million-Eight-Hundred-Thousand Dollars (\$1,800,000.00) (“Sales Tax Incentive Cap”)

The parties recognize that the various incentives set forth herein will be distributed and received over time. It is understood and agreed that, subject to the ten-year limitation on Sales Tax Share-back set forth above, once the Incentive Cap is reached for each sub-category of incentives described in sub-sections (5) (a) and (5) (b) above, no further waivers, reimbursements or Sales Tax Share-back will be available under this Agreement.

8. **Reimbursement of Lodging Tax Collections.** In the event the Town lawfully imposes an occupation tax applicable to lodging services offered or delivered within the Property and as further subject to the limitations set forth in this Section 8 below, the Town shall pay to Developer an amount equal to one-hundred percent (100%) of all lodging tax collections actually received by the Town within the Property.
 - a. **Limitation on Duration.** The obligation to reimburse lodging tax revenue as provided in this Section 8 shall expire at the conclusion of a ten-year period commencing on the date upon which retail lodging sales activity first commences within each Facility or any portion thereof.
 - b. **Waiver of Lodging Tax Appeals, Payment of Refunds/Credits.** In the event of a lodging tax protest or appeal, any credits or reductions of lodging taxes for which reimbursement has previously been paid by the Town shall be credited against future lodging tax reimbursements which may be owed by the Town under this Section 8. For example, if Developer protests or appeals a lodging tax assessment and receives a reimbursement of such lodging taxes from the Town pending outcome of the appeal, but later receives a credit as a result of the protest or appeal, any amount credited to Developer by the Town as a result of the protest or appeal shall become a credit against any future lodging tax reimbursements due to Developer by the Town in an equal amount. In the event that, due to imposition of the limitations set forth in sub-section 10 (a) above, no further lodging tax reimbursements are anticipated, Developer shall immediately pay to the Town an amount equal to the credit established in this sub-section 8 (b).
9. **Miscellaneous.**
 - a. **TABOR.** Nothing herein shall be deemed a multiple-fiscal year obligation in violation of the limitations set forth in Article X, Section 20 of the Colorado Constitution. All waivers, reimbursements and sums payable hereunder by the Town in any future fiscal year shall be subject to legal availability and annual appropriation.
 - b. **Subsequent legislation, constitutional limits.** The Town shall not be required to reimburse Developer in the event that subsequent legislation adopted by the State of Colorado makes such reimbursement unlawful, or in the event a court of

competent jurisdiction declares any portion of this Agreement or legislation authorizing payment under this Agreement to invalid or unconstitutional.

- c. **Compliance With Title 31, Article 15, Part 9, C.R.S.** In connection with providing these incentives, the Town agrees to comply with any obligations imposed pursuant to Section 31-15-903, C.R.S., including the notification requirements of sub-section (4) thereof.
- d. **Waiver of Confidentiality.** As a condition of the Town's undertakings as set forth herein, Developer, for itself and all subsequent sales tax licensees doing business within the Facilities, hereby voluntarily waives its right to confidentiality as provided in *Windsor Municipal Code* Section 4-3-640 for the entire period during which reimbursements are due under this Agreement, and further consents to disclosure of sales and use tax information specific to taxable activity taking place within the Property during said entire period. Developer's waiver and consent under this Section extends to all taxable activity taking place within the Property, and specifically permits public discussion and analysis before Town governmental and administrative bodies.
- e. **Assignment.** The right to receive the tax refunds to be paid under this Agreement may be assigned by Developer to any person or entity later taking record title to the Property or to whom responsibility for operation of the Facility is transferred. No such assignment shall, however, be effective until Developer has provided the Town with written notice of the person(s) or entity/entities to whom record title has been transferred and/or operational responsibility has been transferred.
- f. **Entire Agreement.** This writing constitutes the entire agreement between the parties with respect to its subject matter, and supersedes any prior written or oral communication, negotiations, agreements, representations and understandings between them with respect to its subject matter. Nothing herein shall be deemed a modification, variance or excuse from the requirements of the *Windsor Municipal Code* with respect to site planning, subdivision improvements and applicable corridor standards.
- g. **Modification.** This Agreement may not be modified, enlarged or altered, except in writing, signed by both parties.
- h. **No Third Party Beneficiaries.** No person not a signatory hereto shall have any right to seek enforcement or declaration of status under this Agreement. No third party beneficiaries are intended.
- i. **Attorney fees, costs of litigation.** In the event of litigation between the parties arising out of this Agreement, and in which the Town shall prevail, in addition to any judgment for damages or declaratory relief, Developer shall pay all costs

incurred by the Town, including attorney fees, expert witness fees and other costs of suit.

- j. **Venue.** This Agreement shall be governed by and construed in accordance with the law of the State of Colorado. Venue for all purposes shall be deemed proper in the District Court of Weld County, Colorado.
- k. **No Waiver.** A waiver by either party of a breach of any of the provisions of this Agreement shall not constitute a continuing waiver or a waiver of any subsequent breach of the same or another provision of this Agreement.
- l. **Severability.** If any part, term or provision of this Agreement is held by the courts to be illegal or otherwise unenforceable, such illegality or unenforceability shall not affect the validity of any other part, term of provision, and the rights of the parties shall be construed as if the part, term or provision in question was never part of this Agreement.
- m. **Covenant Running with the Land.** This Agreement shall be deemed to run with the Property and, upon its execution by the parties, shall be recorded by the Town with the Larimer County Clerk and Recorder. Upon execution by the parties, this Agreement shall be binding upon the parties, their respective successors and assigns.

In witness whereof, the parties have executed this Agreement as of the Effective Date.

TOWN OF WINDSOR, COLORADO

WINDSOR HOTEL PARTNERS, LLC

BY: Kristie Melendez, Mayor



BY: Alpesh Patel, CEO

Building Permit Fee Estimate for Commercial or Industrial buildings

NOTICE
**The Plan Review Fee
 Fire District Fee and
 Administrative Fee
 shown on this
 estimate shall be
 collected at the time
 the bulding permit
 application is
 submitted**

Date:	9/19/2016
Name of requestor:	Alpesh Patel
Ph/Fx # or e-mail add:	apatel@kanahotelgroup.com
Subdivision Name:	
Address:	
Lot size in SF:	110,000
Use:	Hotel
Building Size in SF:	61,000

Town of Windsor
 Planning Department
 301 Walnut Street
 Windsor, CO 80550
 970 674-2436
 fx 970 674-2456

ESTIMATE ONLY: ALL FEES ARE SUBJECT TO CHANGE WITHOUT NOTICE. ESTIMATED FEES ARE REFLECTIVE OF THE CURRENT AMOUNTS IN EFFECT AT THE TIME OF THIS ESTIMATE REQUEST. PLEASE CONTACT THE PLANNING DEPARTMENT FOR ANY FEE CHANGES AS YOU ARE GETTING CLOSER TO SUBMITTAL OF A BUILDING PERMIT APPLICATION. **SEE PAGES 2-3 FOR FEE EXPLANATION.**

Line #	Valuation	\$8,000,000
2	Electrical Valuation	\$1,000,000

3	Building Fee	Based on valuation - see schedule		\$15,167.65
4	Electrical Fee	Based on valuation - see schedule		\$11,615.00
5	Construction Meter	Always \$57.50		\$57.50
6	Plan Review Fee	65% of line 3		\$9,858.97
7	Administrative Fee	25% of lines 3, 4, and 5		\$6,710.04
8	Raw Water	Fort Collins Loveland Water District	970-226-3103	
9	Water Plant Investment	Fort Collins Loveland Water District	970-226-3103	
10	Sewer Plant Investment	Fort Collins Loveland Water District	970-226-3103	
11	Drainage Fee	See Notes Below		\$17,780.94
12	Water Meter and Yoke	Fort Collins Loveland Water District	970-226-3103	
13	Irrigation Meter	contact engineer	N/A	
14	Fire District Fee	Fire district fee schedule		\$40,300.00
15	Windsor Use Tax	3.95% of 1/2 of Valuation - Line 1		\$158,000.00
16	Larimer County Use Tax	0.65% of 1/2 of Valuation - Line 1		\$26,000.00
17	Road Impact Fee	Per Ordinance 2008-1318 - see schedule		\$152,400.00
18	CAC Development Fee		N/A	
18	TOTAL			\$437,890.10

Building Permit Fee Estimate for Commercial or Industrial buildings

- 1 Valuation is based upon materials and labor for entire building/project, not inclusive of the land, infrastructure, landscaping, etc.
- 2 Electrical valuation is based upon materials and labor for electrical portion of building/project, not inclusive of the land, infrastructure, landscaping, etc.
- 3 Building Permit Fee: \$3,827.65 for the first \$1,000,000 plus \$1.62 for each additional \$1,000.00 or fraction thereof.
Formula for this permit: $\$7,000,000/1000 \times \$1.62 + \$3,827.65 = \$15,167.65$
- 4 Electrical Permit Fee: \$115.00 plus \$11.50 for each additional \$1,000.00 or fraction thereof.
Formula for this permit: $\$1,000,000/1000 \times \$11.50 + \$115.00 = \$11,615$
- 5 Construction Meter: Always \$57.50
- 6 Plan Review Fee: 65% of line #3 for new commercial bldgs & new 8+ unit multi-family, 30% of line #3 for all other residential and some finishes. $\$15,167.65 \times .65 = \$9,858.97$
- 7 Administrative Fee: 25% of lines 3, 4, and 5. $\$15,167.65 + \$11,615. + \$57.50 \times .25 = \$6,710.04$
- 8 Raw Water Fee: Site specific and dependent upon water district, type of project, and location - please contact Fort Collins Loveland Water District 970.226.3103
- 9 Water Plant Investment - please contact Fort Collins Loveland Water District 970.226.3103
- 10 Sewer Plant Investment - please contact Fort Collins Loveland Water District 970.226.3103

Building Permit Fee Estimate for Commercial or Industrial buildings

- 11 Drainage fee: Based upon lot square footage - Formula: Impervious Rate Factor dependent upon use and land coverage x \$0.1838 x Area in Square feet - Please see Ordinance 2003-1148 for detailed information - This fee is dependent upon amount of land covered by parking and buildings,
Formula for this permit: $110,000 \times \$0.1838 \times .83 = \$16,780.94$ ***Please note that this fee is an estimate based upon the expected lot coverage, but the fee may be lower, based upon percentage of lot coverage and landscaping, which will be determined upon submittal of a site plan to the Planning Department.
- 12 Water Meter Yoke & Pit - please contact Fort Collins Loveland Water District 970.226.3103
- 13 Irrigation Meter - please contact Fort Collins Loveland Water District 970.226.3103
- 14 Fire District Fee - Based on Valuation - \$5300 for first \$1,000,000 plus \$125 for each additional \$25,000 of raction thereof. $\$7,000,000 / 25,000 \times 125 + \$5300 = \$40,300.00$
- 15 Windsor Use Tax: 3.95% of 1/2 of the Valuation
Formula for this permit: $\$8,000,000 \times 0.5 \times .0395 = \$158,000.$
- 16 Larimer County Use Tax: 0.65% of 1/2 of the Valuation
Formula for this permit: $\$8,000,000 \times .5 \times .0065 = \$26,000$
- 17 Road Impact Fee: Based upon proposed use in this building - Please see Ordinance 2008-1318 for detailed information. If a detailed estimate is required, a minimum of \$50.00 is charged and additional consultant fees may be due to determine this cost. The road impact fees are due at issuance of the building permit and should be included in the estimated permit costs.
Formula for this permit: $100 \text{ ROOMS} \times 1,524. = \$152,400.00$
- 18 This total is an estimate based upon today's fees. These fees may change in the future.

Building Permit Fee Estimate for Commercial or Industrial buildings

NOTICE
**The Plan Review Fee
 Fire District Fee and
 Administrative Fee
 shown on this
 estimate shall be
 collected at the time
 the bulding permit
 application is
 submitted**

Date:	9/19/2016
Name of requestor:	Alpesh Patel
Ph/Fx # or e-mail add:	apatel@kanahotelgroup.com
Subdivision Name:	
Address:	
Lot size in SF:	220,000
Use:	Hotel
Building Size in SF:	125,000

Town of Windsor
 Planning Department
 301 Walnut Street
 Windsor, CO 80550
 970 674-2436
 fx 970 674-2456

ESTIMATE ONLY: ALL FEES ARE SUBJECT TO CHANGE WITHOUT NOTICE. ESTIMATED FEES ARE REFLECTIVE OF THE CURRENT AMOUNTS IN EFFECT AT THE TIME OF THIS ESTIMATE REQUEST. PLEASE CONTACT THE PLANNING DEPARTMENT FOR ANY FEE CHANGES AS YOU ARE GETTING CLOSER TO SUBMITTAL OF A BUILDING PERMIT APPLICATION. **SEE PAGES 2-3 FOR FEE EXPLANATION.**

Line #	1 Valuation	\$17,000,000
	2 Electrical Valuation	\$2,000,000

	3 Building Fee	Based on valuation - see schedule	\$29,747.65
	4 Electrical Fee	Based on valuation - see schedule	\$23,115.00
	5 Construction Meter	Always \$57.50	\$57.50
	6 Plan Review Fee	65% of line 3	\$19,335.97
	7 Administrative Fee	25% of lines 3, 4, and 5	\$13,230.04
	8 Raw Water	Fort Collins Loveland Water District	970-226-3103
	9 Water Plant Investment	Fort Collins Loveland Water District	970-226-3103
	10 Sewer Plant Investment	Fort Collins Loveland Water District	970-226-3103
	11 Drainage Fee	See Notes Below	\$33,561.88
	12 Water Meter and Yoke	Fort Collins Loveland Water District	970-226-3103
	13 Irrigation Meter	contact engineer	N/A
	14 Fire District Fee	Fire district fee schedule	\$85,300.00
	15 Windsor Use Tax	3.95% of 1/2 of Valuation - Line 1	\$335,750.00
	16 Larimer County Use Tax	0.65% of 1/2 of Valuation - Line 1	\$55,250.00
	17 Road Impact Fee	Per Ordinance 2008-1318 - see schedule	\$313,944.00
	18 CAC Development Fee		N/A
	18 TOTAL		\$909,292.04

Building Permit Fee Estimate for Commercial or Industrial buildings

- 1 Valuation is based upon materials and labor for entire building/project, not inclusive of the land, infrastructure, landscaping, etc.
- 2 Electrical valuation is based upon materials and labor for electrical portion of building/project, not inclusive of the land, infrastructure, landscaping, etc.
- 3 Building Permit Fee: \$3,827.65 for the first \$1,000,000 plus \$1.62 for each additional \$1,000.00 or fraction thereof.
Formula for this permit: $\$16,000,000/1000 \times \$1.62 + \$3,827.65 = \$29,747.65$
- 4 Electrical Permit Fee: \$115.00 plus \$11.50 for each additional \$1,000.00 or fraction thereof.
Formula for this permit: $\$2,000,000/1000 \times \$11.50 + \$115.00 = \$23,115$
- 5 Construction Meter: Always \$57.50
- 6 Plan Review Fee: 65% of line #3 for new commercial bldgs & new 8+ unit multi-family, 30% of line #3 for all other residential and some finishes. $\$29,747.65 \times .65 = \$19,335.97$
- 7 Administrative Fee: 25% of lines 3, 4, and 5. $\$29,747.65 + \$23,115. + \$57.50 \times .25 = \$13,230.04$
- 8 Raw Water Fee: Site specific and dependent upon water district, type of project, and location - please contact Fort Collins Loveland Water District 970.226.3103
- 9 Water Plant Investment - please contact Fort Collins Loveland Water District 970.226.3103
- 10 Sewer Plant Investment - please contact Fort Collins Loveland Water District 970.226.3103

Building Permit Fee Estimate for Commercial or Industrial buildings

- 11 Drainage fee: Based upon lot square footage - Formula: Impervious Rate Factor dependent upon use and land coverage x \$0.1838 x Area in Square feet - Please see Ordinance 2003-1148 for detailed information - This fee is dependent upon amount of land covered by parking and buildings,
Formula for this permit: $220,000 \times \$0.1838 \times 0.83 = \$33,561.88$ ***Please note that this fee is an estimate based upon the expected lot coverage, but the fee may be lower, based upon percentage of lot coverage and landscaping, which will be determined upon submittal of a site plan to the Planning Department.
- 12 Water Meter Yoke & Pit - please contact Fort Collins Loveland Water District 970.226.3103
- 13 Irrigation Meter - please contact Fort Collins Loveland Water District 970.226.3103
- 14 Fire District Fee - Based on Valuation - \$5300 for first \$1,000,000 plus \$125 for each additional \$25,000 of raction thereof. $\$16,000,00 / 25,000 \times 125 + \$5300 = \$85,300.00$
- 15 Windsor Use Tax: 3.95% of 1/2 of the Valuation
Formula for this permit: $\$17,000,000 \times 0.5 \times .0395 = \$335,750.00$
- 16 Larimer County Use Tax: 0.65% of 1/2 of the Valuation
Formula for this permit: $\$17,000,000 \times .5 \times .0065 = \$55,250.$
- 17 Road Impact Fee: Based upon proposed use in this building - Please see Ordinance 2008-1318 for detailed information. If a detailed estimate is required, a minimum of \$50.00 is charged and additional consultant fees may be due to determine this cost. The road impact fees are due at issuance of the building permit and should be included in the estimated permit costs.
Formula for this permit: $206 \text{ ROOMS} \times 1,524. = \$313,944$
- 18 This total is an estimate based upon today's fees. These fees may change in the future.



EXHIBIT A - Kana Hotel Group Phase I & II

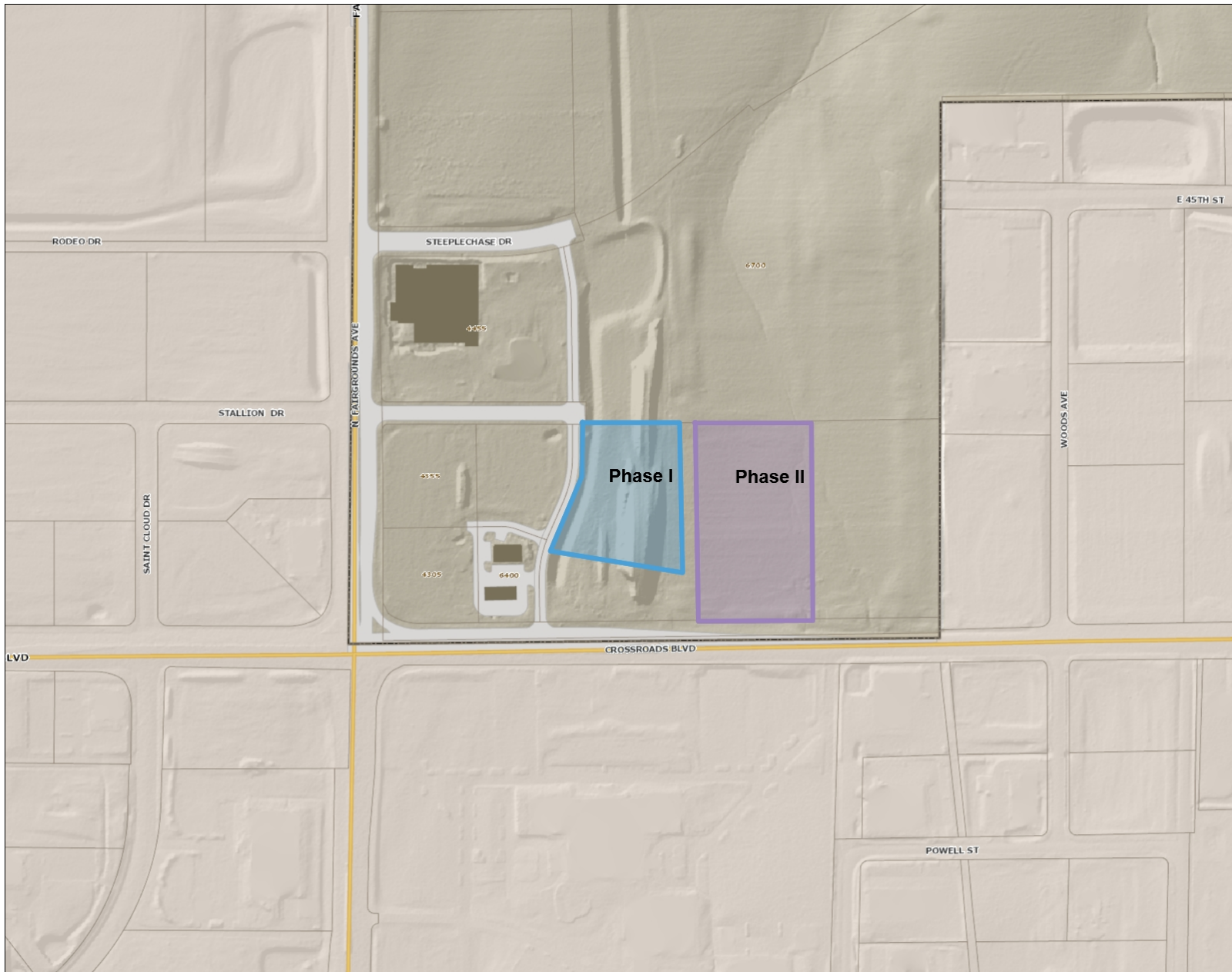

Legend

Parcels

Notes

Parcel ID: 8635309007 (Portion of)
Approx. Location: South of Stallion drive,
east of private drive, north of crossroads Blvd

0.15 0 0.08 0.15 Miles



1: 4,800



This product is for informational purposes and may not have been prepared for, or be suitable for legal, engineering, or surveying purposes. Users of this information should review or consult the primary data and information sources to ascertain the usability of the information.

Date Prepared: 11/10/2016 10:24:01 AM

EXHIBIT B
Cost Analysis 9.23.2016

Hotel Property All Phases (3 hotels - 2 buildings)				
Expenses:				
Building	\$ 28,000,000.00			
equipment (FFE from restaurants etc)	\$1,500,000			
Total investment	\$ 29,500,000.00			
	Approx. Windsor Sales Tax REVENUE 3.00%	Approx. Windsor Sales Tax REVENUE .95% (CRC)		
Income:				
Year 1				
Sales tax (all hotels)	\$360,000.00	\$114,000.00		
Real & Personal Property Tax (approx)	\$ 102,550.60			
Fees from all hotels	Phase I Hotel Fees (1 hotel)	Phase II Hotel Fees (2 hotels)		
*based off of information provided by Windsor New Commercial Fee estimate form from Kana Hotel Group			Totals	
Building Fee	\$15,167.65	\$29,747.65	\$44,915.30	reimburse at C.O.
Electrical Fee	\$11,615.00	\$23,115.00	\$ 34,730.00	reimburse at C.O.
Construction Meter	\$57.50	\$57.50		
Plan Review Fee	\$9,858.97	\$19,335.97	\$29,194.94	reimburse at C.O.
Administrative Fee	\$6,710.04	\$13,230.04	\$19,940.08	waive
Raw Water	N/A	N/A		
Water Plant Investment	N/A	N/A		
Sewer Plant Investment	N/A	N/A		
Drainage Fee	\$17,780.94	\$33,561.88	\$51,342.82	reimburse at C.O.
Water Meter and Yoke	N/A	N/A		
Irrigation Meter	N/A	N/A		
Fire District Fee	\$40,300.00	\$85,300.00		
Windsor Use Tax	\$158,000.00	\$335,750.00	\$493,750.00	waive
Larimer County Use Tax	\$26,000.00	\$55,250.00		
Road Impact Fee	\$152,400.00	\$313,944.00		
Total FEES	\$ 437,890.10	\$ 909,292.04		
Total fee waiver/reimbursement from Town	\$182,490.98	\$382,541.92		
Total fee reimbursement from SafeBuilt Fees	\$36,641.62	\$72,198.62		
Total incentives Request for Fees (all hotels)	\$750,000.00	\$750,000.00		
Total sales tax revenue (10 years) estimated all hotels	\$3,600,000.00	\$1,140,000.00		
Total Property Tax (10 Years) estimated all hotels	\$1,006,165.00			
10 year 50% share back of sales (all hotels)	\$ 1,800,000.00			
All Phases Hotel Property fee waivers	\$ 565,032.90			
SafeBuilt fees (reimbursed by town)	\$ 108,840.24			
total fees waived and/or reimbursed	\$ 673,873.14			
Payback for fee waivers	2.38 years			



The Ranch

Larimer County Fairgrounds
and Events Complex

Master Plan

November 14, 2016

Our Charge

- Prepare a Master Plan that encourages innovation, fiscal and environmental sustainability and the creation of public spaces
- Define the vision, business, and operational goals for the next 20 years
- Must be market supportable and financially grounded
- Elevate user experience and maintain relevancy
- Always consider the health and safety of people and animals

Master Plan Objectives

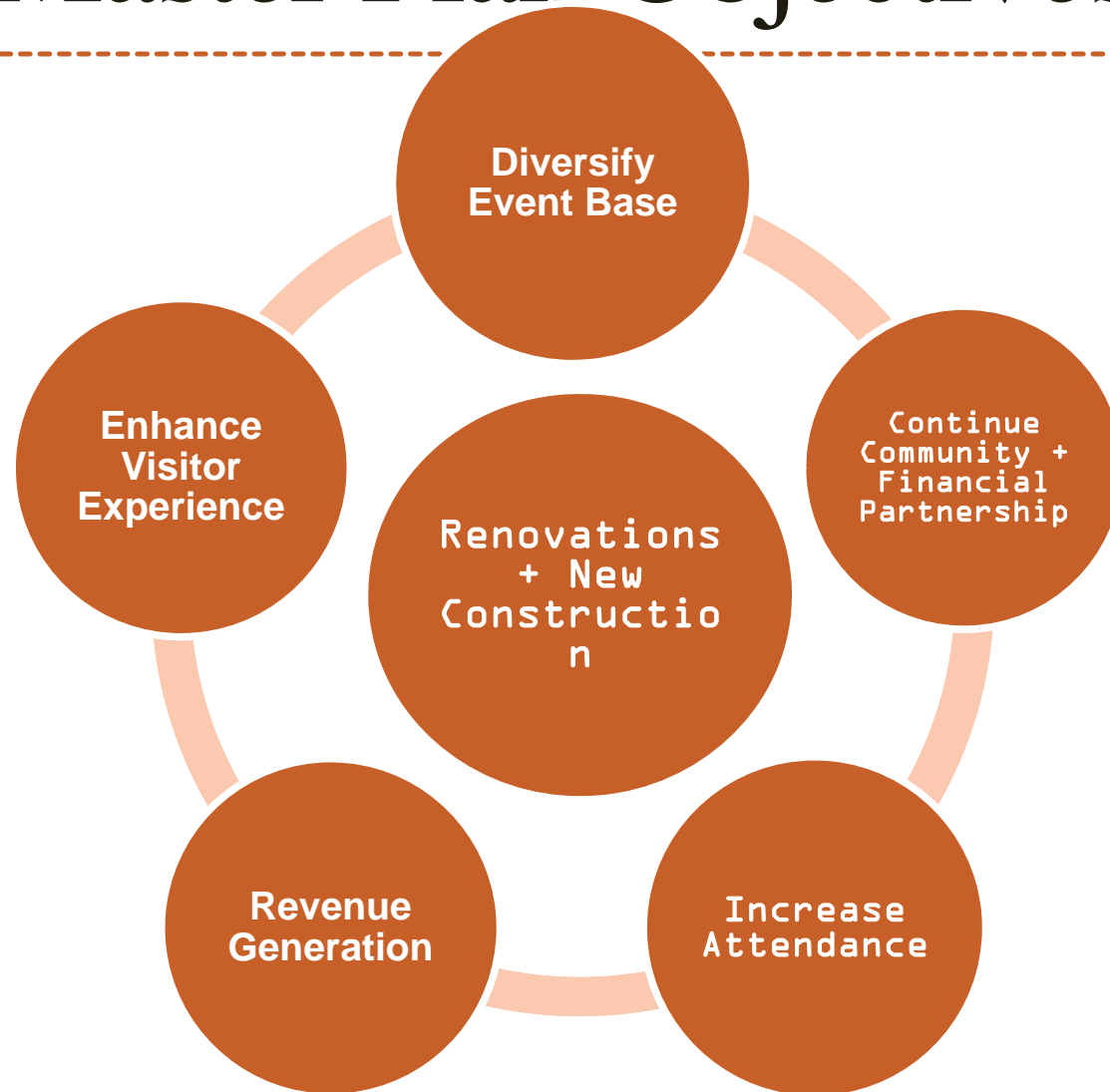

Work Completed To Date

- Developed a vision that will serve as guideposts for the entire Master Plan
- Engaged stakeholders county-wide
- Evaluated facility conditions and needs
- Completed the preliminary market assessment
- Developed preliminary building concepts and site layout concepts

Process + Schedule

PHASE 1: FOUNDATION (JUNE)

- **Stakeholder Interviews**
- **Online Questionnaire #1**

What methods should we use to reach you and what is your initial feedback?

PHASE 2: VISIONING (JULY-SEPT)

- **Public Scoping Meetings**
Aug. 22- Aug. 24, 2016
- **Online Questionnaire #2**

Refine the vision, issues, objectives and opportunities for the plans.

PHASE 3: ALTERNATIVES (OCT-JAN)

- **Alternatives Public Workshops:** Oct 21 (Eagles Game), Nov 16 (Chilson Center), Nov 17 (Courthouse)
- **Online Questionnaire #3**

Provide input on the preferred opportunities and programs.

PHASE 4: DRAFT PLANS (FEB-MARCH)

- **Draft Plan Public Meetings**
- **Public Review Period**
- **Online Questionnaire #4**

Input on the preferred options, strategies and draft plans.

PHASE 5: FINAL PLANS (APRIL-MAY)

- **Final Plan Presentations**
- **Public Hearings**

Refine the final plans, support the adoption and define the steps for implementation.

5 Event Series

Who's Involved?

100,000+

people have received
direct notification about
opportunities

2,800+

people have commented
via events, questionnaires
or online

Methods:

- Stakeholder Interviews
- Press Releases
- The Ranch Stakeholder Committee and Technical Advisory Committee
- Online Questionnaires #1 + #2
- New West Fest
- Neighborhood Postcards
- Larimer County Fair & Rodeo
- Outdoor Public Meetings @ Horsetooth, Carter Lake, and The Ranch
- BEC Events
- Entrance Gates @ Carter + Horsetooth
- Facebook
- Constant Contact Emails

Feedback So Far

Strong Community Interest In More:

- Concert/Music or Entertainment Events
- Family Entertainments
- Enhanced Outdoor Festivals, Events and Amenities
- Community Events
- Equine Shows or other Livestock Events
- Transportation Convenience

Creating a Balanced Plan

- Market research assessed potential demand, opportunities and program improvements
- Strategies for long-term viability of The Ranch
- Preliminary market assessment culminated in prioritizing market segments by demand potential

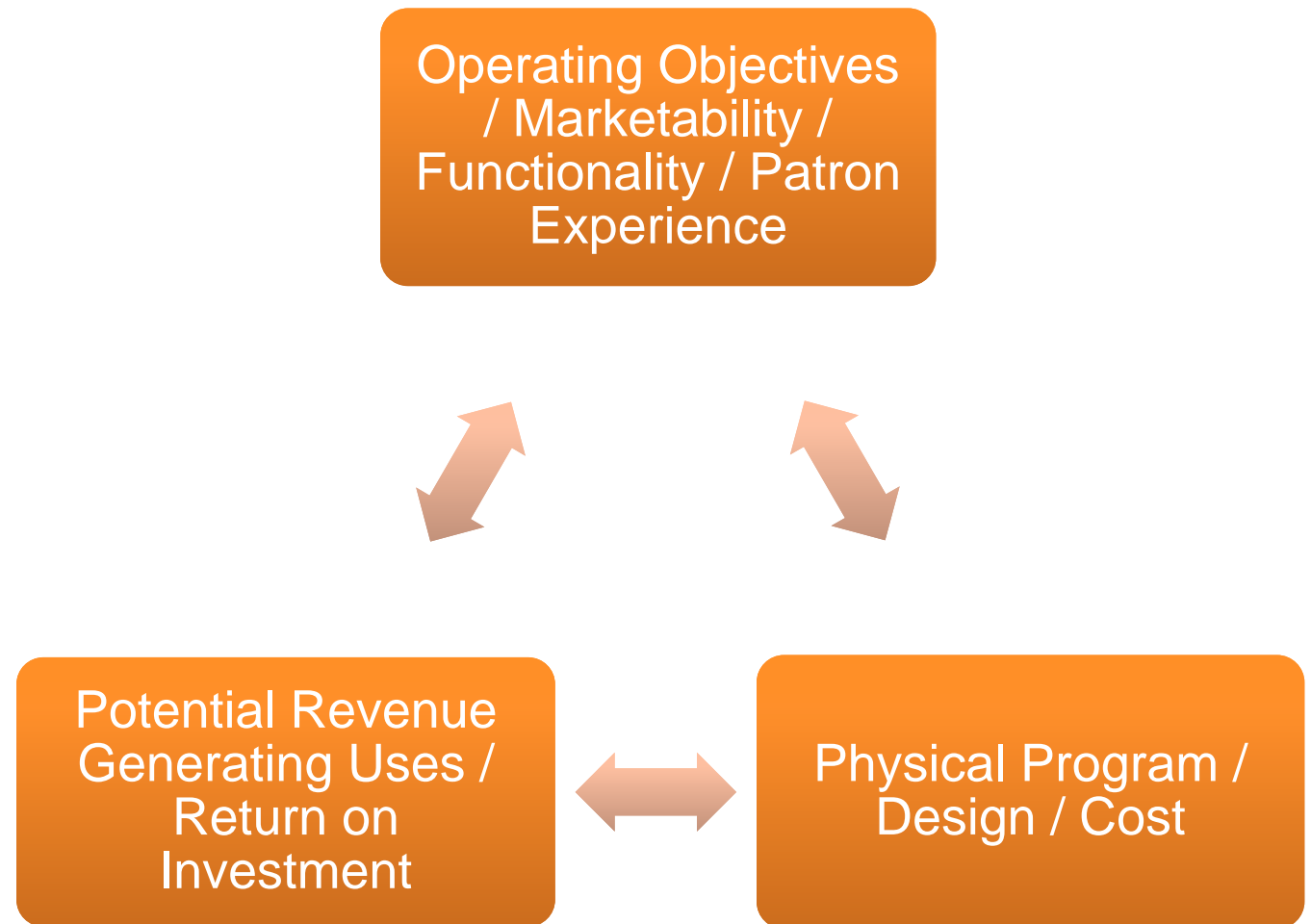

Preliminary Market Study Findings

Market Segment	Demand Potential	Rationale
Equine/Livestock	High	<ul style="list-style-type: none"> Local significance and in-line with the vision Existing base of business Existing program elements Potential to increase number and scope of events Ability to host more simultaneous events Opportunity for incremental new revenues and economic impact
Festivals/Outdoor Events	High	<ul style="list-style-type: none"> Relative limited venues in primary market Industry trends, particularly toward local/regional festivals Strong interest expressed from public Highly attended and highly profitable events
Exhibit/Meeting/Banquet	Moderate	<ul style="list-style-type: none"> Existing base of business could increase Relative limited venues in primary market Ability to support regional businesses Multiple, diverse exhibit users/target markets (e.g., equine, agricultural, outdoors, large equipment, etc.) Diverse meeting/banquet demand generators (e.g., community, corporate, agricultural, etc.) Year-round activity Potential associated revenue streams
Sports/Entertainment Events	Moderate	<ul style="list-style-type: none"> Existing base of business Supply of established competitive facilities in the region Industry trends
Fair	Low	<ul style="list-style-type: none"> Any improvements will support/augment Fair activity Limited opportunity to significantly increase revenues

Next Steps

Phase 3: Concept Narrowing via

- Community Outreach on October 21 (Eagles Game), November 16 (Chilson Center), November 17 (Courthouse) and Questionnaire #3
- Final Market Study
- Preferred Alternative (January)
- Cost/Benefit Analysis

Phase 4: Public Draft

- Concept Details
- Preliminary Draft Master Plan (February)
- Stakeholder and Technical Advisory Committee Meeting #3
- Public Draft Master Plan + Public Meetings (March)



MEMORANDUM

Date: November 14, 2016
To: Mayor and Town Board
Via: Kelly Arnold, Town Manager
Scott Ballstadt, AICP, Director of Planning
From: Josh Olhava, AICP, Senior Planner
Subject: Proposed elevation changes at Highland Meadows Golf Course Subdivision
11th Filing – Townhomes – Landmark Homes, developer
Location: East of Fairgrounds Avenue and south of and adjacent to Colonial Drive
Item #: D.2

Background:

The developer, Landmark Homes, is proposing building elevation changes to their approved townhome site plan under the name Highland Meadows Golf Course Subdivision 11th Filing – Site Plan. The site plan was approved by the Town Board on June 8, 2015. The site is currently under construction. The developer is proposing different stone and new columns, roof elements and materials to upgrade the buildings. The changes do not impact the plat or building envelopes shown on the site plan. The changes only impact the elevation sheets of the approved site plan.

Staff has reviewed the enclosed 'proposed elevations' and agrees with the developer that the new elevations are an improvement. The changes would add more architectural interest to the buildings. Staff presented these changes to the Planning Commission at their October 19th meeting under communications. Chairman Schick commented that "*the request looks to be an upgrade from what was previously proposed and has no concerns with the changes*". The rest of the Planning Commission was in agreement.

Since the site plan was originally approved by Planning Commission and Town Board, the proposed changes are being brought back before the Planning Commission and Town Board. If there are no concerns from the Town Board, the request to change the elevations will be handled administratively moving forward. However, if the Town Board has any concerns on the proposed changes and wants to take formal action, then staff will schedule the elevation changes to the site plan as an action item for recommendation from the Planning Commission and final review and determination by the Town Board on a future agenda.

Enclosures: approved elevations
proposed elevations

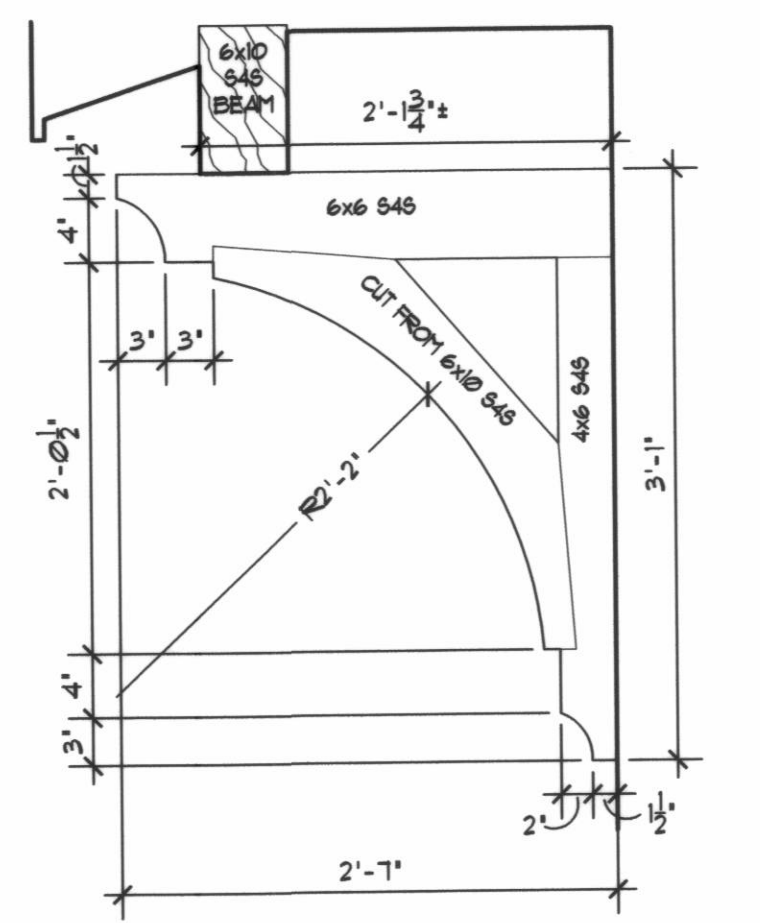

Wood Bracket Detail
1" = 1'-0" At Garage

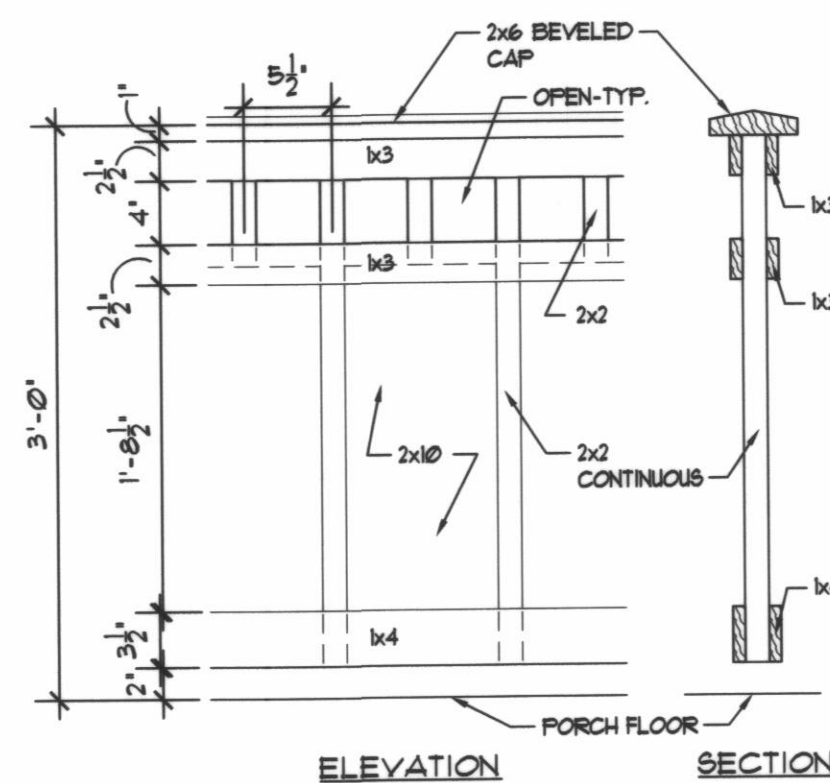

Railing Detail - Typ.
1" = 1'-0" At Porch

NOTE: WITH THE EXCEPTION OF THE DECORATIVE LANTERNS, ALL LIGHTING SHALL BE FULL CUT-OFF FIXTURES MOUNTED IN FULL CUT-OFF POSITION

NOTE: ALL BUILDING MOUNTED UTILITIES AND EQUIPMENT (INCLUDING GAS METERS) ARE TO BE PAINTED TO MATCH THE ADJACENT BUILDING FINISH.

EXTERIOR FINISH LEGEND

- 6" LAP SIDING FINISH
- 8" LAP SIDING FINISH
- STRAIGHT EDGE SHINGLE SIDING
- MANUFACTURED STONE VENEER

** FINISH COLORS TO BE SUBMITTED UNDER SEPARATE EXHIBIT

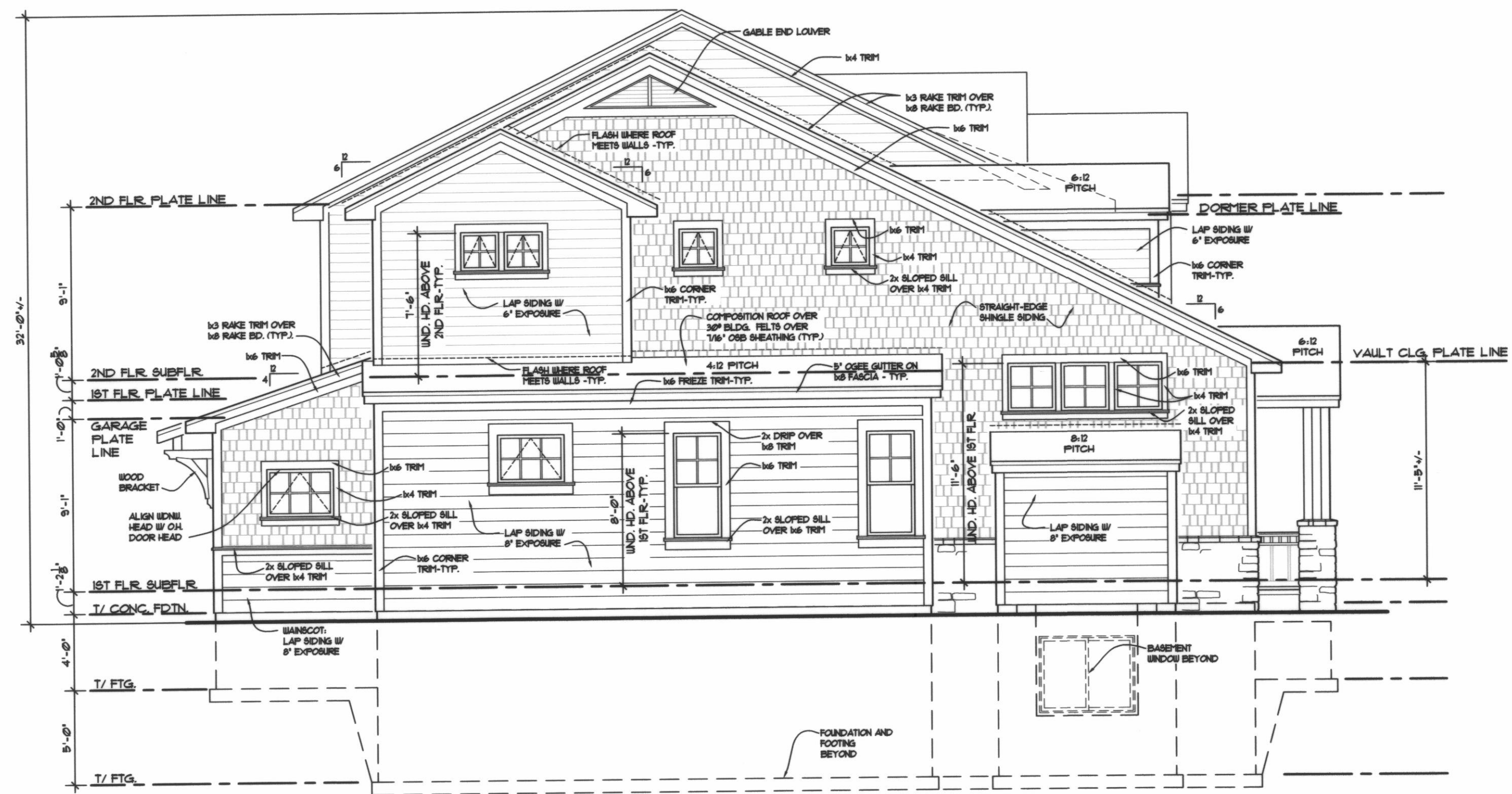

Left Elevation
3/16" = 1'-0" Four-Plex

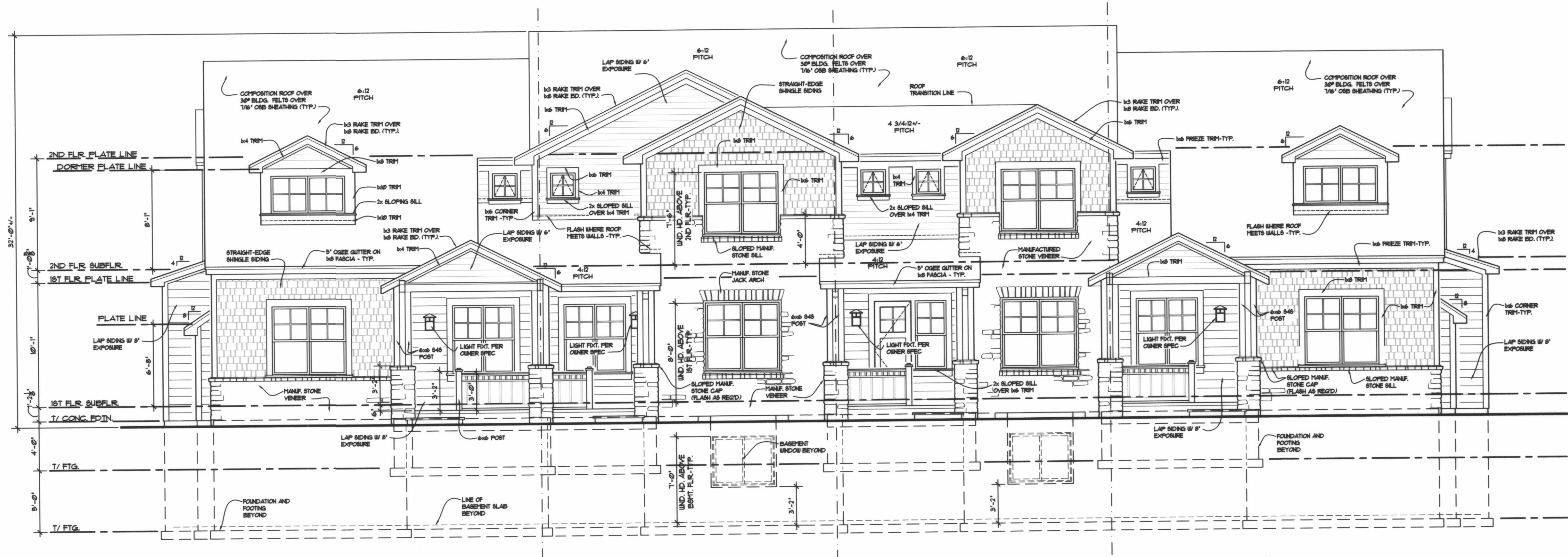

Front Elevation
3/16" = 1'-0" Four-Plex



REVISIONS
FINAL MYLAR

DATE
June 15, 2015
JOB No.
519512
SHEET No.

NOTE: WITH THE EXCEPTION OF THE DECORATIVE LANTERNS, ALL LIGHTING SHALL BE FULL CUT-OFF FIXTURES MOUNTED IN FULL CUT-OFF POSITION

NOTE: ALL BUILDING MOUNTED UTILITIES AND EQUIPMENT (INCLUDING GAS METERS) ARE TO BE PAINTED TO MATCH THE ADJACENT BUILDING FINISH.

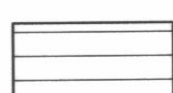
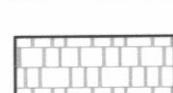
EXTERIOR FINISH LEGEND

-  6" LAP SIDING FINISH
-  8" LAP SIDING FINISH
-  STRAIGHT EDGE SHINGLE SIDING
-  MANUFACTURED STONE VENEER

** FINISH COLORS TO BE SUBMITTED UNDER SEPARATE EXHIBIT

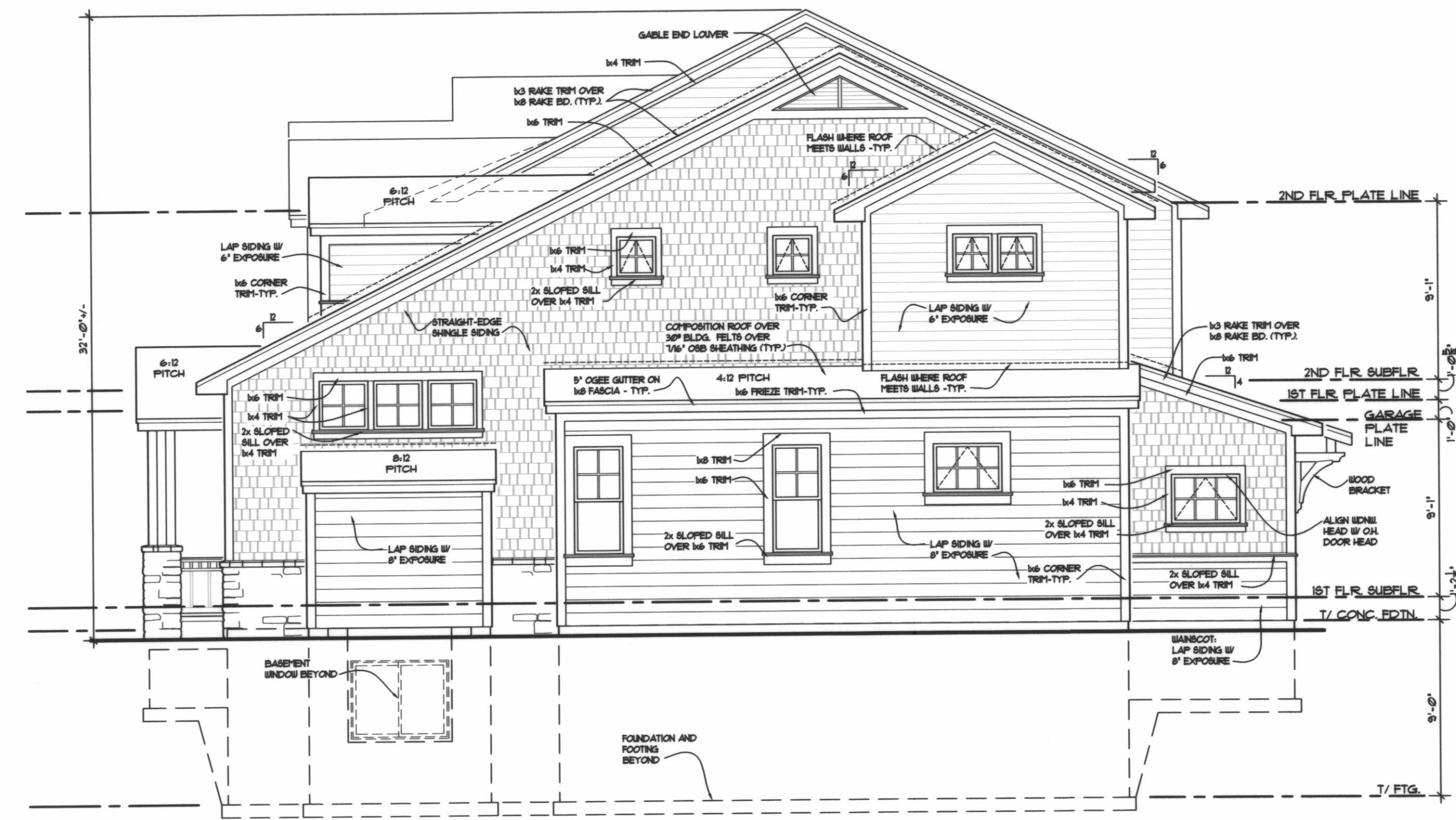

Right Elevation
 3/16" = 1'-0"

Four-Plex

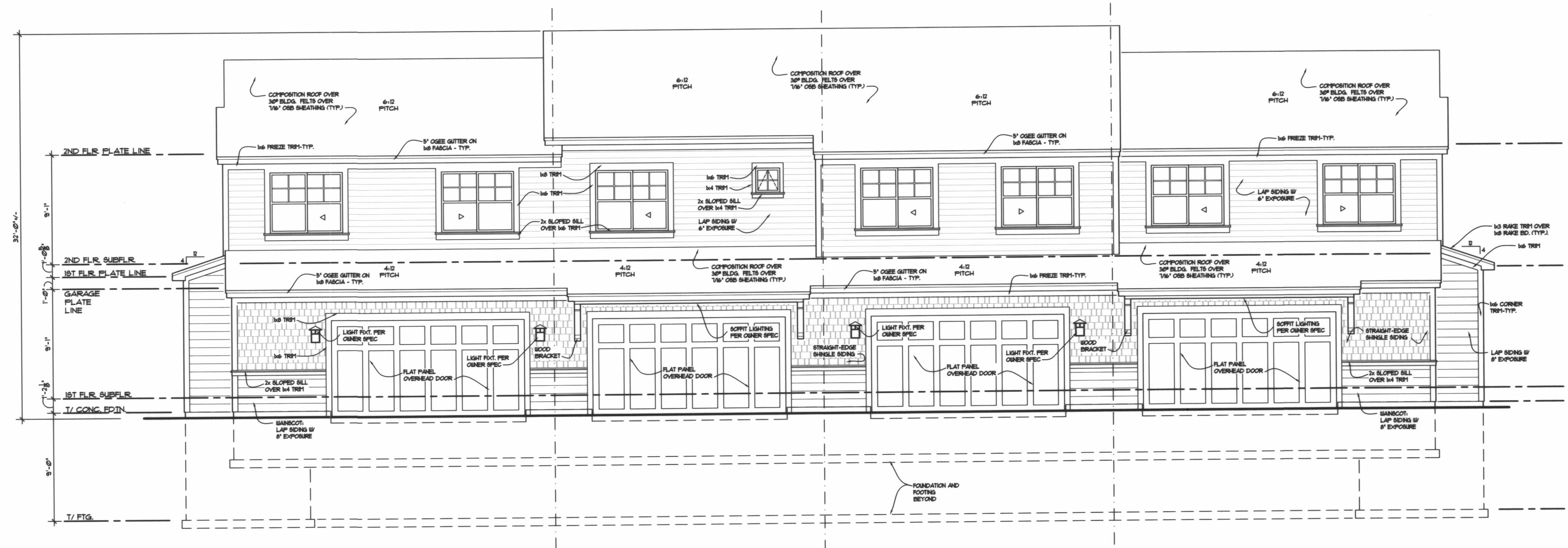

Rear Elevation
 3/16" = 1'-0"

Four-Plex



Light
Craftmade
Z4414-88



Brown (12)

Metal Roof

Gutters
Musket Brown

Flashing
Brown

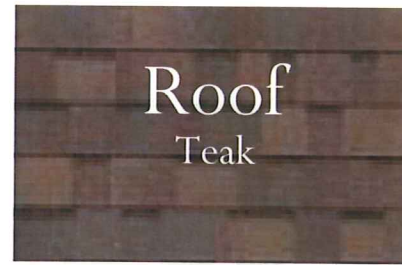

Roof
Teak

Shake Siding

Benjamin Moore
Harvest Brown
2104-30



Lap Siding

Benjamin Moore
Barnwood
CSP - 115



Board and Batten

Benjamin Moore
Revere Pewter
HC - 172



Trim

Caribou
Benjamin Moore
8766



Stone

Telluride - Field



LANDMARK
Homes

Ravenna

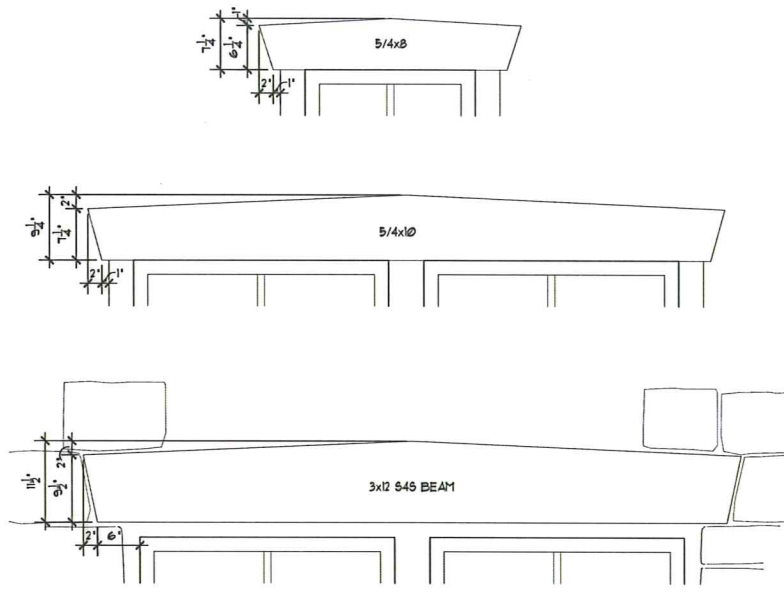

Typical Window Lintels
1/4" = 1'-0"

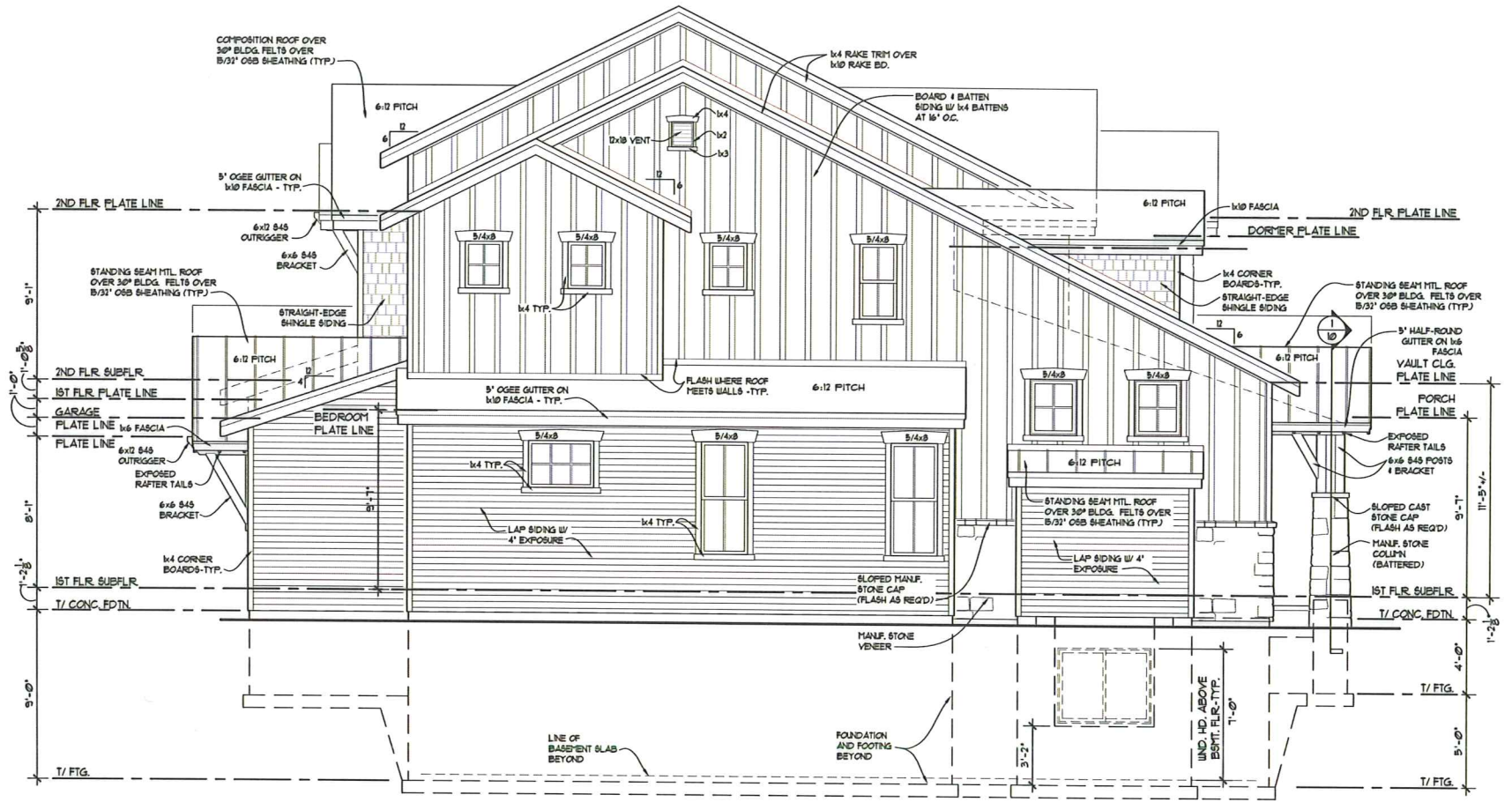

Left Elevation
1/4" = 1'-0"

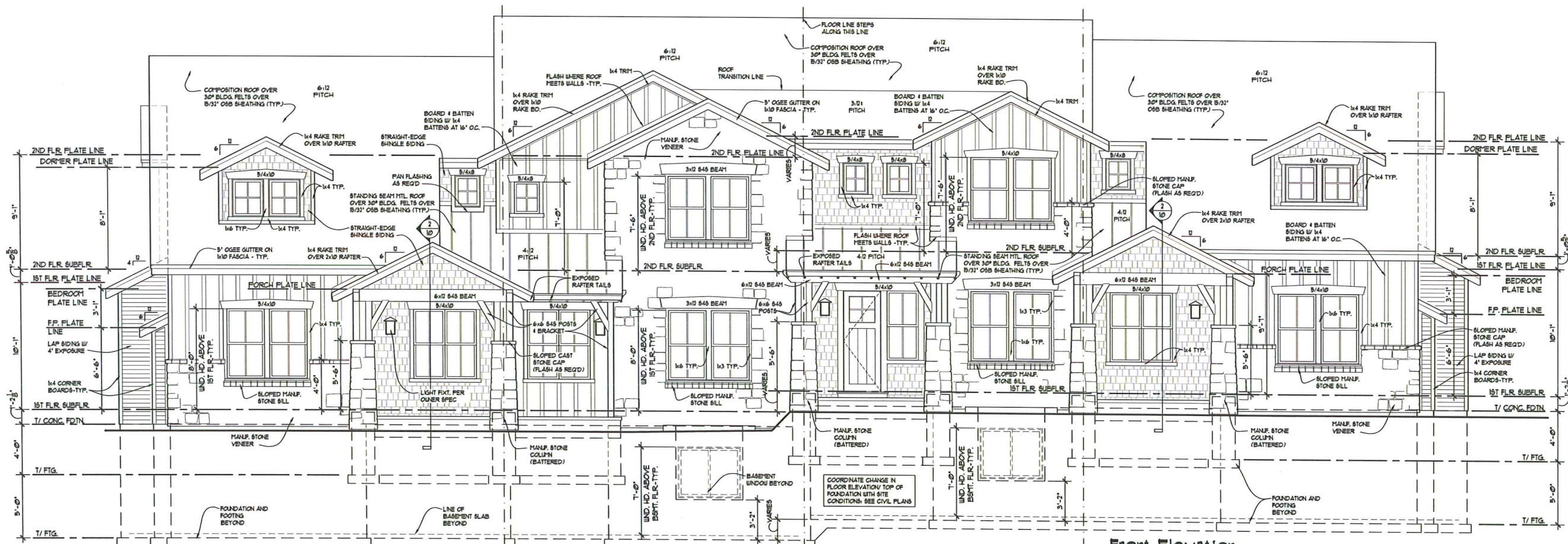

Front Elevation
1/4" = 1'-0"

ARCHITECTURE
LANDSCAPE
ARCHITECTURE
INTERIORS
ENERGY SERVICES

NSPJ

ARCHITECTSSM

P. 913.831.1415
F. 913.831.1563
NSPJARCH.COM
© COPYRIGHT 2013

3515 W. 75TH ST., SUITE 201
PRAIRIE VILLAGE, KS 66208



NEW TOWNHOMES FOR:

LANDMARK HOMES

RAVENNA AT LA RIVA (4 UNIT BUILDING)

HIGHLAND MEADOWS GOLF COURSE
WINDSOR, COLORADO

DRAWING RELEASE LOG

REVISIONS

DATE
02/18/2016

JOB NO.
551814

DRAWN BY:
JM

SHEET NO.

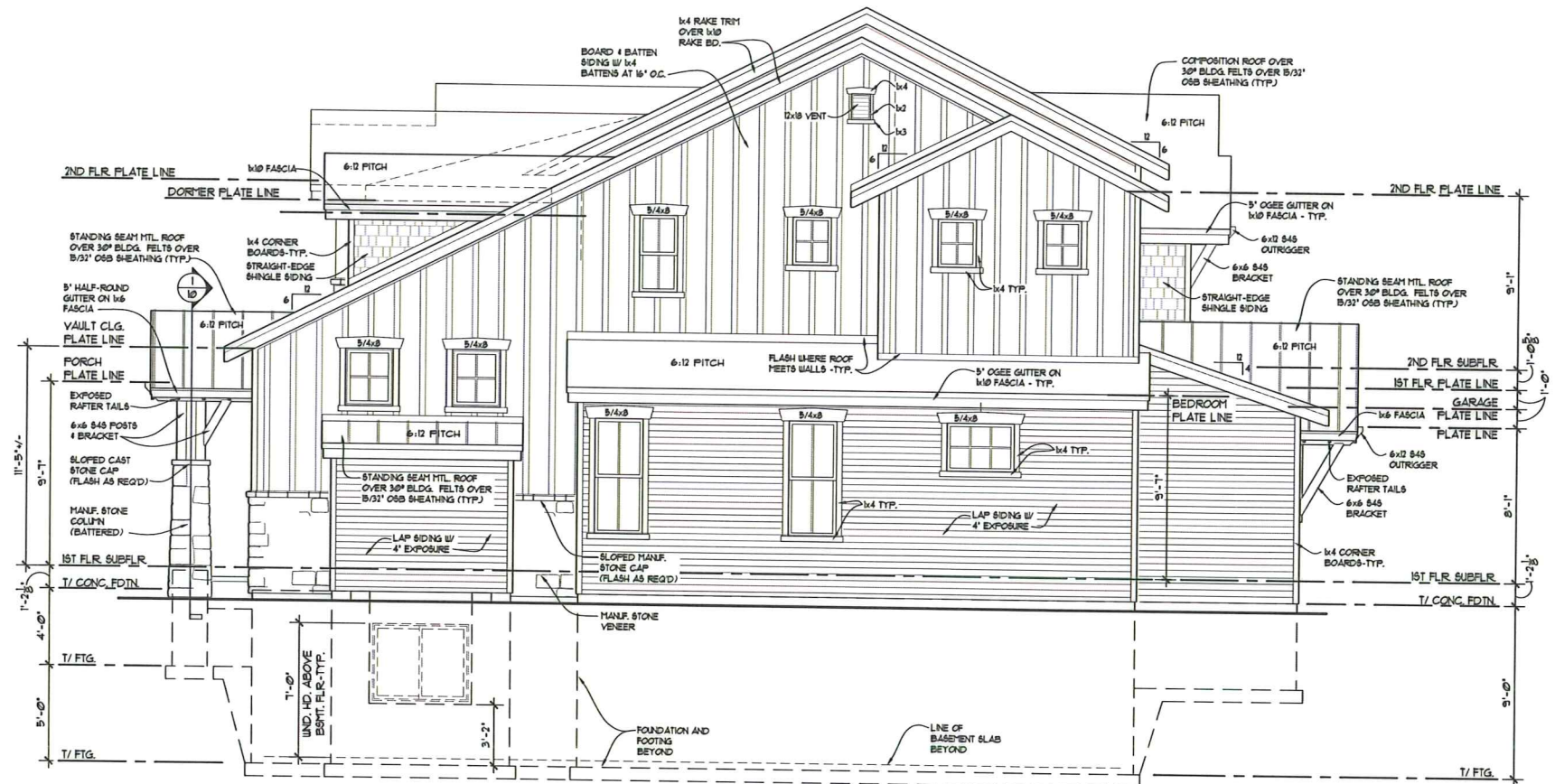

Right Elevation
1/4" = 1'-0"

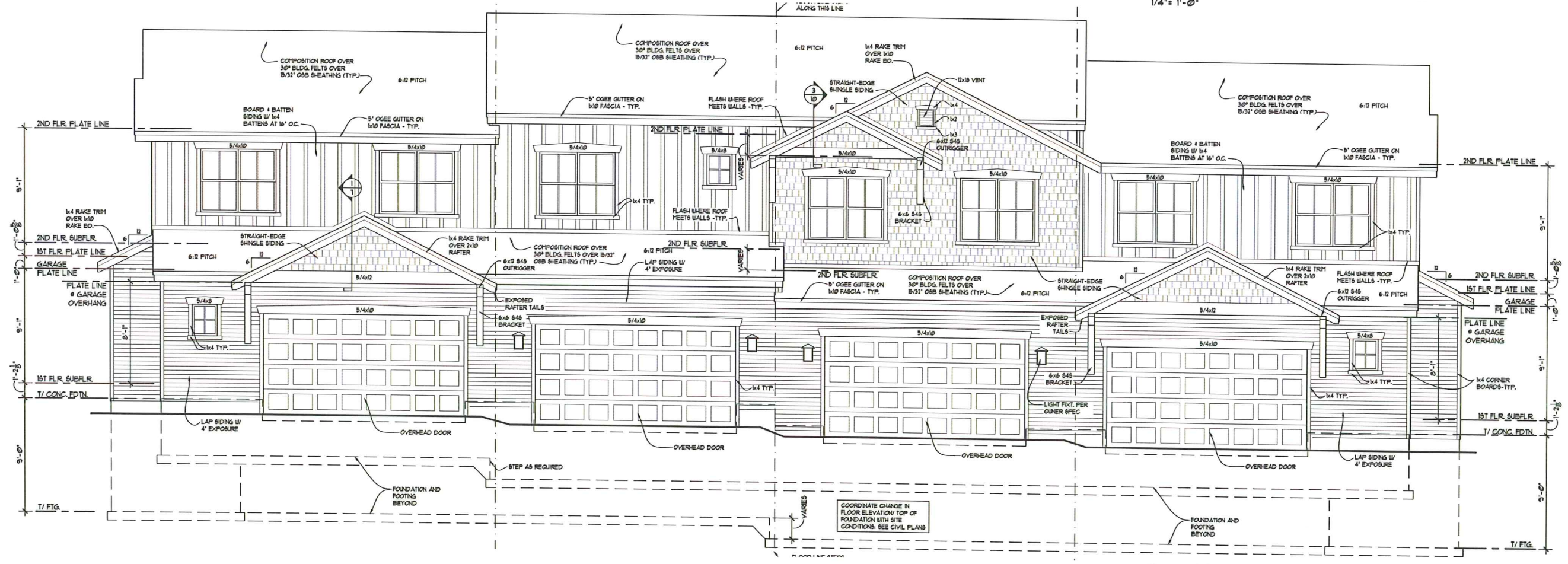

Rear Elevation
1/4" = 1'-0"

ARCHITECTURE
LANDSCAPE
ARCHITECTURE
INTERIORS
ENERGY SERVICES

NSPJ

ARCHITECTSSM

P. 913.831.1415
F. 913.831.1563
NSPIARCH.COM

3515 W. 75TH ST., SUITE 201
PRAIRIE VILLAGE, KS 66208

STATE OF COLORADO
CL. NO. 40336
EXPIRES 12/31/16
LICENSED ARCHITECT

NEWTOWNHOMES FOR:

LANDMARK HOMES

RAVENNA AT LA RIVA (4 UNIT BUILDING)

HIGHLAND MEADOWS GOLF COURSE

WINDSOR, COLORADO

DRAWING RELEASE LOG

REVISIONS

DATE
02/18/2016
JOB NO.
551814
DRAWN BY:
JM
SHEET NO.

6